

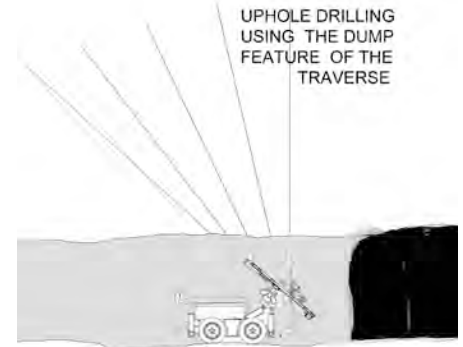

PHQ3000LHP Pneumatic Drill Carrier PHQ36IR Long-Hole Drill Set-up Operating/Parts/Repair Manual

Update June 2017

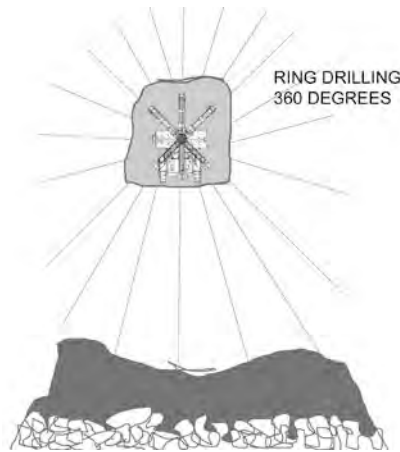

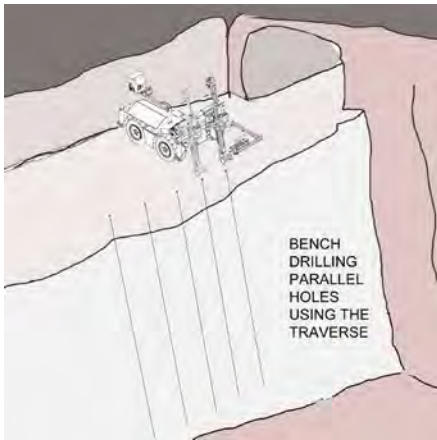

Assembled Drill Carrier Dimensions

Overall Length (with operators stand and traverse) 97" (2464 mm)

Overall Width Carrier Body 51" (1295 mm)

Traverse Width 83" (2108 mm)

Maximum Horizontal Movement of Drill Center on Traverse 66" (1677 mm)

Overall Height to Top of Trammig Control Box 60" (1524 mm)

Wheel base (length between wheels) 38" (965 mm)

Traction (width between wheels) 38" (965 mm)

Ground Clearance to Bottom of Lift Cylinder 6.5" (165 mm)

Ground Clearance to Bottom of Carrier 12" (305 mm)

Centerline of Drill Swivel Carrier Lifted to Maximum 57" (1448 mm)

Centerline of Drill Swivel Carrier Lowered to Maximum 49" (1244 mm)

Drill Carrier Dimensions

Length of Carrier (without operators stand) 80" (2032 mm)

Width of Carrier to Outside of Wheels 51" (1295 mm)

Height to Top of Trammig Controls 60" (1524 mm)

Height to Top of Tent Cover 43" (1092 mm)

Height Carrier (Less Tent Cover & Controls) 28" (711 mm)

Distance Between Front and Rear Cylinders 80" (2032 mm)

Distance Between Front Cylinders 38" (965 mm)

Distance Between Rear Cylinders 38" (965 mm)

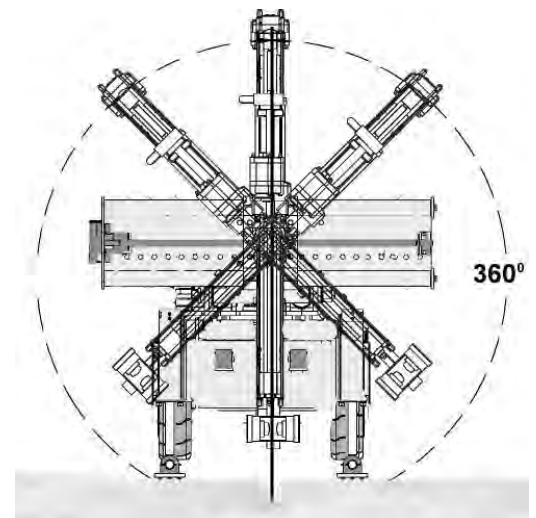

| Height at Maximum Lift Stabilizers | | |
|------------------------------------|-----|---------|
| A | 8" | 203 mm |
| B | 20" | 508 mm |
| C | 44" | 1118 mm |
| D | 66" | 1676 mm |

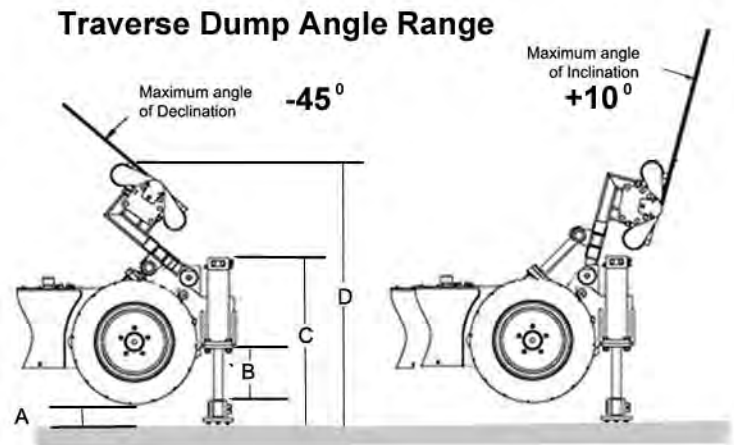

Rig with, Traverse Declined, Drill and Feed in Trammig Position

Traverse Width 83" (1219 mm)

Carrier Width 51" (1219 mm)

Overall Length from end Carrier to end of Drill Centralizer 130" (3302 mm)

Overall Height to Top of Feed Assembly Height 94" (2387 mm)

Turning Radius (Carrier with Drill Upright) 110" (2794 mm)

Trammig speed up to 10° gradient 1.2 km/h

Ground Clearance Carrier Body 12" (305 mm)

Ground Clearance to Bottom of Lift Cylinders 6.5" (203 mm)

Maximum Grade Ability 25% (15°)

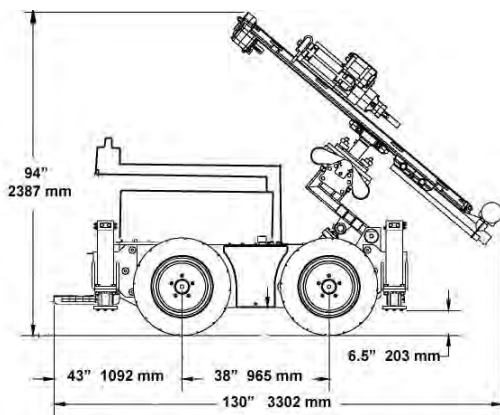

Lubricant Filling Capacities

Hydraulic oil tank 7.3 gallons (27.6 L)

Lubricator 1.5 gallons (5.7 L)



Tramming the Drill Carrier



Safety Point: Check the immediate area around both sides of the carrier in the direction you are travelling to be sure no personnel are in the operating zone.

Grip a control handle in each hand and slowly push the two handles forward simultaneously to move the carrier in the direction of the forward facing booms.



Look over your shoulder and pull back on both of the control handles simultaneously to move the carrier in the reverse direction.



To rotate the carrier to the left push forward on the handle on the right side at the same time as you pull back on the handle on the left side. While tramming the carrier will turn to the left when the left handle is returned to the neutral position or at any time the right handle is further advanced than the left handle



To rotate the carrier direction to the right push forward on the handle on the left side at the same time as you pull back on the handle on the right side. While tramming the carrier will turn to the right when the right handle is returned to the neutral position or at any time the left handle is further advanced than the left handle



Release both handles and they will return to the neutral position stopping the flow of compressed air to the motors and the carrier will come to a stop. With the flow of air stopped the motors act as a passive breaking system and the Carrier does not move.



Towing the Drill Carrier

The carrier can be towed behind a scoop tram on the level. Raise all hydraulic lift cylinders to the maximum retract position. Move the drill to the center of the traverse and turn the drill and feed horizontal to parallel the traverse. Angle the traverse back to lift the drill and hoses, fold in the remote control, secure trailing hoses from the remote control, drill, feed, and centralizer. Remove the bull hose and coil in the bucket of the scoop. Use a one inch heavy duty tow chain



The two chain drives must be placed in neutral. Remove the bolt from the center of each of the drive caps and set the bolt to one side. **Safety Point:** The carrier should be on a level surface or the wheels chocked before working on the chain. The air motors and chain act as a passive braking system.

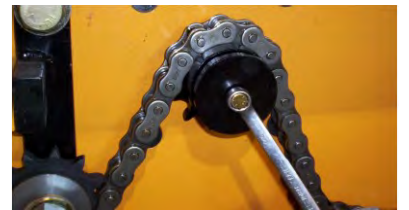

Remove the caps (SJ7858). The caps may have become very snug and it may be necessary to use a flat head screwdriver to pry the caps from the sprockets.



Reverse the Caps and replace it on the sprockets with the keyway facing outwards so that the drive sprockets are now disengaged and turn freely on the drive shafts.

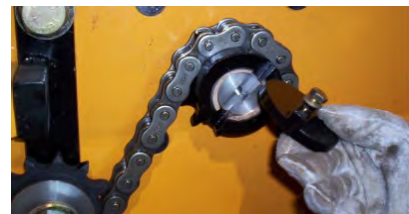

Secure the Caps. Replace the bolts removed earlier and tighten in to place. The carrier is now ready for towing. When finished towing reverse the procedure to engage the chain drives to the drive shafts for tramping.

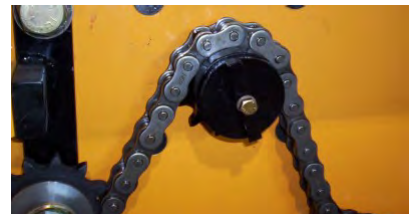

Replacing the Chain Drive (Y8040)

Safety Point: Before beginning to work on the drill carrier always lift the carrier extending all four hydraulic lift cylinders to the maximum height to ensure wheels are lifted off the ground and that the carrier is securely anchored. With the carrier in this position the wheels can turn freely once the chain is removed making it much easier to string in a new chain around the wheels and sprockets.



Open the chain guard on either side of the drill carrier. Remove a bolt from one end of the guard, loosen the bolt at the other end and swing the guard out of place.

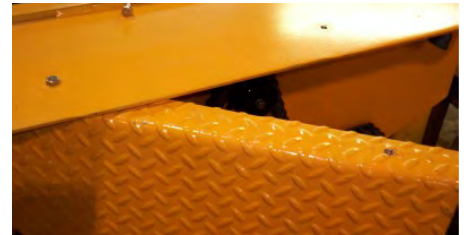

Replace the Chain (Y8040). Lay out a new chain by draping it over the sprockets as shown and pull tight.



Bring both ends of the chain together near the bottom of the large wheel sprocket and temporarily join the ends of the chains together using a clamp as shown.

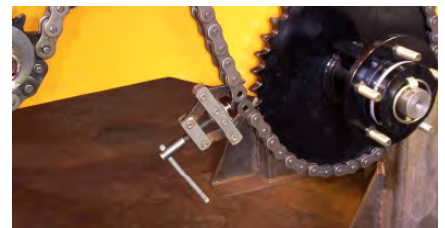

Insert a Master Link (Y80401) and secure with a **Half Link (Y80402)** to complete the chain. View the following page to adjust the tension of the chain. Replace the chain guard before operating the carrier.

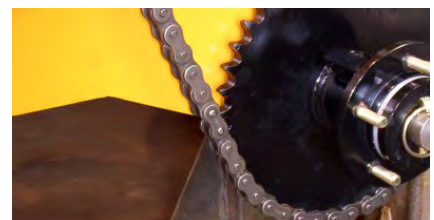

Replacing the Chain Drive (Y8040)

Safety Point: Before beginning to work on the drill carrier always lift the carrier extending all four hydraulic lift cylinders to the maximum height to ensure wheels are lifted off the ground and that the carrier is securely anchored. With the carrier in this position the wheels can turn freely once the chain is removed making it much easier to string in a new chain around the wheels and sprockets.



Loosen the Locking Nut on the Tensioner Assembly (J5220) and rotate further towards the head of the bolt.



Turn the Bolt in a clockwise direction to push the tension arm more tightly into the chain or turn counter-clockwise to move the adjustment out and loosen the chain.

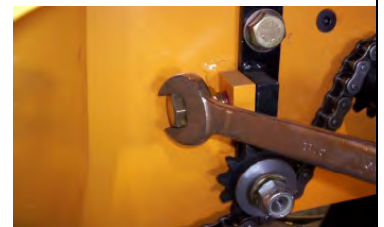

Increase the Tension until the chain is rigid and no slack is evident between the top two idler sprockets. There is no need to tighten the chain beyond this point.



Lock the Chain tension setting by tightening the locking nut against the plate to secure the assembly from further movement.

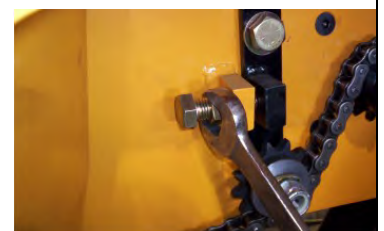

PHQ36IR Independent Rotation Drill Operating procedure

The 36IR Drifter is designed for a long and economical life drilling holes of 38 mm to 75 mm in diameter up to 30 m in depth. Correct application and use of the machine will ensure that the best drilling performance and economy are obtained.

Specifications:

| | | |
|---------------------------------|------------------------------|-------------------|
| Bore | 114 mm | 4.49 inches |
| Stroke | 86 mm | 3.39 inches |
| Overall Length | 870 mm | 34 inches |
| Mass (Weight) | 120 kg | 265 lb |
| Blows per Minute | 1630 at 500 kPa | |
| Frequency | 27 Hz @ 500 kPa | |
| Air Requirements (optimum) | 12 L/sec @ 7 bar | 450 cfm @ 100 psi |
| Water Requirements (optimum) | 37 L/min @ 5 bar | 10 gpm @ 70 psi |
| Drill Percussion Air Connection | 40 mm BSP | 1 ¼ inch BSP |
| Rotation Air Connections | 25 mm BSP | 1 inch BSP |
| Centralizer Air Connections | 13 mm BSP | ½ inch BSP |
| Air Water Flushing Connection | 20 mm BSP | ¾ inch BSP |
| Flushing Tube | 11 mm wet 14 mm dry | |
| Rotation Motor Gear Type | 4.0 kW at 120 RPM at 500 kPa | |
| Drill Shank Four Spine | 44 mm | 1 ¾ inch |

Capability:

| | | |
|------------------------------|----------------------|-------------------------|
| Hole Size (Diameter) | 38 mm – 89 mm | 1.5 in – 3.5 in |
| Hole Depth | Up to 46 meters | Up to 150 feet |
| Reaming of pre-drilled holes | From 38 mm to 127 mm | From 1.5 inch to 5 inch |

Mountings

Normally the PHQ36IR Drill is mounted the MKV Aluminum Screw Feed Aluminum Guide Shell powered by a STANMO Feed Motor for up to 2 meter (6 foot) change drill rods. The STANMO Feed Motor is available as a single powered motor or as a double (or dual) powered motor. The machine may be also be mounted on a Chain Feed Cradle to suit any existing feed system with special mounting details for drilling with up to 3 meter (10 foot) steel changes.

Safety Before Starting the Drill

Drill operators should first carefully read all the following safety instructions. Failure to abide by these instructions could lead to damage to equipment, serious bodily harm or even death.

- Never operate equipment while under the influence of alcohol, medication or drugs.
- Wear appropriate clothing fitted to the body, no loose garments or accessories which could become entangled in machinery. Wear all approved safety equipment, hard hat with ear muffs (and ear plugs), gloves, hard toed boots, safety glasses and any other equipment mandatory to the work place.
- Always have ear protection in place when operating the drills that produce noise above the level of 85dBA. Ear muffs alone are not sufficient to muffle this level of harmful noise from a rockdrill. Wearing ear plugs that shape to properly fit the inner contour of the ear in addition to ear muffs is mandatory.
- Always check the work area when entering at the beginning of a shift to ensure the area is safe to work in. Check the back and walls for loose and scale if necessary. A proper scaling bar should be kept in the workplace at all times.
- Keep the workplace tidy, drill rods stacked neatly, tools elevated out of water puddles on the floor and all unnecessary items removed from the work area to avoid tripping
- Ensure untrained or unauthorized persons are safe in the work area and direct visitors to keep a safe distance from operating equipment, before starting the drill.
- Look over the drill set-up to be sure the column bars are secure and all clamp nuts are tightened (or the carrier is properly positioned and sitting firmly on the hydraulic lift cylinders).
- If the airlines have been disconnected for any reason the air supply hose must be blown to be sure there is no accumulated water or debris in the hose.
- Flush the water supply hose before connecting it to the Remote Control panel.
- Check the F61 large capacity lubricator to be sure it is filled with sufficient proper rockdrill oil to provide lubrication to the drill for the shift.
- Before opening the air supply ensure all levers on the Remote Control Panel are in neutral or off positions.
- Before operating controls the operator must understand the function of each control.
- Do not exceed the recommended capacity of this equipment by increasing the level of the supply of compressed air pressure beyond 120 cfm (8 Bar).
- Unauthorized modifications to the equipment or use of replacement parts or components not purchased from PHQ without prior approval from PHQ may render the equipment unsafe to operate or induce early failure of components, any changes to the equipment or components voids PHQ's warranty.

Operating Controls

There are five controls for the PHQ36 Independent Rotation drilling machine. They are all contained in a single remotely operated control panel:

1 Rotation - Lever forward to rotate drill rod clockwise.
Lever back to rotate drill rod counterclockwise.

2 Flushing - Lever forward to active water flushing.
Lever back to active air flushing.

3 Centralizer - Lever forward to open the centralizer.
Lever back to close centralizer.

4 Drill Feed - Lever forward to move the drill forward.
Lever back to move the drill backwards.

5 Percussion - Lever forward to active the percussion.
Lever back to stop the percussion.

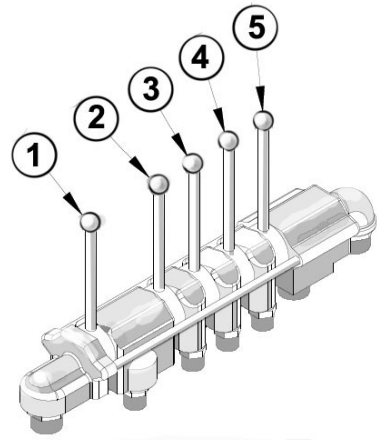

Collaring a Hole

In Brief:

- 1) Position the centralizer and drill bit close to the rock face as possible in the line of drilling
- 2) Move Centralizer lever (3) forward to close the centralizer jaws and stabilize the drill rod.
- 3) Move Flushing lever (2) forward one third (water flowing out of the bit).
- 4) Move Rotation lever (1) forward one third (drill rod and bit rotating clockwise slowly).
- 5) Move Drill Percussion lever (5) forward on third (drill beginning to hammer slowly)
- 6) Move Drill Feed lever (4) forward one third (bit contacts rock face begins chattering)
- 7) Advance and Retard Drill Feed lever (4) to enable the bit to cut a square face on rock.
- 8) After penetration to depth of six inches (150mm) advance all levers to optimize drilling rate.

Detail:

To start or "collar" a hole advance the feed control lever (4) to bring the drill bit within about 10 mm of the rock surface. It is advantageous to square an uneven rock face before collaring holes using a shorter drill rod and a "casing" bit that is larger than the diameter of the bit that will drill the hole. The centralizer is used to hold the drill rod rigidly in place when collaring the hole and should be as close to rock face as the set-up will allow. With the casing bit and rod in place close the centralizer on the drill rod by advancing the Centralizer control lever (3). The rod will still advance through the jaws of the centralizer (as the jaws are designed to grip the coupling end of the rod) and the bit will be held firmly in place to begin collaring the hole. Advance the flushing lever (2) to partially open the flushing control valve and provide a low flow of water to the casing drill bit. Gingerly advance the Drill Percussion control valve (5) to start the drill hammering. Advance the rotation control valve (1) to start rotation of the drill rods at about 50 RPM. The drill string should turn anti-clockwise when viewed from the rear. Continue to advance the feed control lever (4) to feed the drill slowly forwards until the bit starts striking the rock with the hammer running at low frequency and continue to advance the Drill Percussion control valve (5) until about one third open. Advance the feed control lever (4) until the drill string is moving backwards and forwards approximately 10mm. Care must be taken to ensure that forward feed pressure does not cause the collaring bit to slip sideways on the rock face. Running at partial throttle and using the Feed Control lever control pressure against the rock face will establish a

clean 'collar' or initial opening to then collar the drill hole on line. Once a good 'collar' has been established gradually advance the feed control lever (4) Drill Percussion control lever to full throttle (5) and Rotation Control lever so rods rotate at about 150RPM. Continue until the bit penetrates about six inches (150mm). Once the hole is well collared and the face of the hole "squared up" shut down the drill and feed, open the centralizer jaws, back the drill on the feed and remove the casing rod and bit.

Drilling in the Floor Installing Casing Pipe:

Drilling in the floor will often require that all the loose rock, dirt and muck be removed from the work place, the exposed surface of rock face blown clean and then inspected for any possibility of "bootleg" holes left from the development work that created the opening. Bootleg holes are usually horizontal holes in the floor area still containing explosives that did not detonate. The explosive can is a serious hazard for a drill operator drilling holes in the floor. It is possible to drill through the "muck" on the floor by first installing a casing to solid rock. This can be accomplished with the driller operating from a remote or shielded location. With the Feed and Drill on-line for the hole loosen the Clamp Cone and drop the Feed so the Centralizer is right down on the floor with the Casing Bit and Short Rod in the drill. Clamp the Feed firmly in the Clamp Cone. The Remote Controls should be pulled as far from the drill as possible and perhaps a robust shield placed between the operator and the hole location. Open the water flushing to full on and drill the casing slowly through the muck until it penetrates solid rock approximately 0.3 meter (1 ft). Stop drilling with the Casing Bit still on bottom with the water flushing still running, loosen the Clamp Cone and use the Feed Control to move the Feed Assembly up until the Centralizer is 0.6 Meter (2 ft) above the floor. Shut down the water flushing and retract the Casing Bit / Rod from the hole. Remove the Casing Bit/Rod and push a suitable length casing pipe into the vacated hole. Replace the Casing Bit/Rod with the first four foot rod placing the bit inside the casing pipe in the hole. Turn on the water flushing to full force and slowly advance the drill bit and rod into the drill hole using rotation only. Press the casing pipe into the hole until it enters the solid rock and bottoms. Resume normal drilling procedure.

- 1 Rotation** - Lever forward to rotate drill rod clockwise.
Lever back to rotate drill rod counterclockwise.
- 2 Flushing** - Lever forward to active water flushing.
Lever back to active air flushing.
- 3 Centralizer** - Lever forward to open the centralizer.
Lever back to close centralizer.
- 4 Drill Feed** - Lever forward to move the drill forward.
Lever back to move the drill backwards.
- 5 Percussion** - Lever forward to active the percussion.
Lever back to stop the percussion.

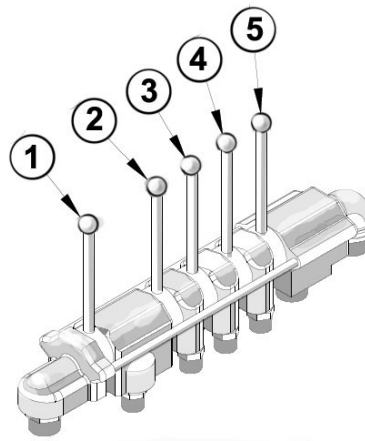

Drilling the first full Drill Rod:

Replace the casing rod-bit assembly with a regular length drill rod and proper sized new bit. Move the drill forward so the bit enters the collared hole. Move the centralizer lever (3) forward to close the centralizer jaws on the drill rod so the bit is held firmly in place and will drill online. Advance the flushing lever (2) to partially open the flushing control valve and provide a low flow of water to the drill bit. Gingerly advance the Drill Percussion control valve (5) to start the drill hammering. Advance the rotation control valve (1) to start rotation of the drill rods at about 50 RPM. The drill

string should turn anti-clockwise when viewed from the rear. Continue to advance the feed control lever (4) to feed the drill slowly forwards until the bit starts striking the rock with the hammer running at low frequency and continue to advance the Drill Percussion control valve (5) until about half open. Advance the feed control lever (4) until the drill string is moving backwards and forwards approximately 10 mm. Simultaneously advance the feed control lever (4) the Drill Percussion control lever and Rotation control lever (1). Move the flushing control lever (2) to the full on position and continue to adjust the hammering and feed of the drill until the Drill Percussion valve (5) is fully on. Adjust the feed control valve (4) until drill string oscillation (sideways vibration) is reduced to a minimum. Adjust the rotation control lever (1) to give a rotation speed of about 100-150 RPM. This rotation speed should be adjusted to give the best penetration speed, generally faster for small holes and softer rock, slower for large holes and very hard rock. Continually adjust the control valves until optimum rotation and feed is achieved. Underfeeding produces a lack of a pressure on the bit at the face so it will cut properly and if the drill string oscillation is allowed to increase it causes damage to the rock drill and drill string. Overfeeding at high feed pressure will end all oscillation however the powerful feed motor can exert such a high pressure it may stall the drill rotation or actually push the drill set-up sideways resulting in misalignment of the drill string in the hole. This can have serious consequences. A rigid bar and arm set-up will prevent the movement of the drill set-up.

Alignment

Alignment of the feed so that the drill shank is exactly on line with the hole is the single most important aspect of drilling. The operator must first “collar” the hole properly on line and then monitor the drill rods while drilling to assure the feed and drill remain “on-line” at all times. The drill must maintain sufficient feed pressure so that the drill string is rigid but oscillating (vibrating from side to side) very slightly at all times when drilling. It is most important that the drill set-up include a centralizer or a rigid hole-spotter. The centralizer should be advanced close to the rock face so that it holds the drill rod/bit rigid and does not allow the bit to slip sideways while collaring. There is no need to keep the Centralizer Jaws closed on the Drill Rods once the drill string is well into the hole, however the driller should close the jaws on the drill rod occasionally to check alignment.

Proper Lubrication

Place a wrench in the stream of air exhausting from the drill and check for adequate lubrication of the drill. A fine mist of oil coming from the exhaust should be evident forming on the wrench within a minute. Check the shank bar where it protrudes from the machine there should be a noticeable ring of oil on the shank next to the front cap of the drill when drilling. The driller should stay alert to any lubrication leaking from joints in the Drill Assembly that could signify a problem within. At any sign of excess water exiting the drill from the Front End around the shank shut the Drill down to ensure the Shank Water Seal has not ruptured as this will wash lubricant out of the Drill. Insufficient lubrication can cause catastrophic damage to the Drill in a matter of minutes.

Drilling the hole to depth (adding drill rods)

In Brief:

- 1) Move the Centralizer lever (3) back to lock the drill coupling within the Centralizer Jaws.
- 2) Move the Rotation lever (1) back to unscrew the drill rod from the coupling.
- 3) Move the Drill Feed lever(4) all the way back to rapidly retract the drill
- 4) Insert a new Drill Rod and thread onto the shank one or two turns by hand.
- 5) Move the Rotation lever (1) forward spinning the shank into the rod and rod into coupling
- 6) Move the Centralizer lever (3) forward to open the jaws and resume drilling.

Detail:

When it is necessary to add threaded drill rods from the string, retard the Rotation Control lever (1) to off, move the Drill Percussion lever (5) back to shut the hammer off pull back on the feed control lever (4) to lift the drill string 20 mm off of the bottom of the hole. Move the feed control lever (4) to the neutral position and advance the Drill Percussion control lever (5) to about the half-power position and allow the drill to hammer the drill string that is being held in place. The action of the hammer at half power vibrates the threaded drill rods loose in the string. Turn off the hammer and push the feed control lever (4) forward to position the coupling in the centralizer jaws. Advance the Centralizer Control valve (3) to close the jaws gripping the coupling. Pull back on the rotation control lever (1) to engage reverse rotation to unscrew the rod from the coupling. Only run the machine with reverse rotation the few seconds it takes to separate the drill rod-coupling connection, then move the rotation control lever (1) to neutral, at the same time pull back on the feed control lever (4) to full open position to rapidly pull the drill down the slide opening up space between the coupling held in the centralizer and the end of the drill shank protruding from the drill. Once the drill has reached full retract position on the feed shell return the feed control lever (4) to the neutral position. Place a drill rod coupling end on the shank bar thread and turn on one or two threads by hand. Move the feed control lever to the forward position to move the drill rod towards the coupling held in the Centralizer. The driller should guide the drill rod thread into the coupling. Once the drill rod thread enters the coupling move the rotation control lever (1) forward to spin the threads together and couple the new drill rod into the string. Once the drill string tightens up open the Centralizer Jaws by pulling back on the Centralizer control lever (3). Move the Feed Control lever (4) fully forward, open the Drill Percussion lever (5) Rotation Control lever (1) and Flushing lever (2) fully to resume drilling. The driller needs to monitor the rotation and vibration of the drill string to set the drill at optimum performance by adjusting the controls as the drill continues drilling.

Tips:

When adding drill rods the driller should pick up the rod while the drill is still running and place the threaded end of the rod in the exhaust from the drill. The exiting air will blow off any debris and add a fine coat of lubricant to the threads. The drill should check the striking end of the rod for chips in the face or wear of the threads. When the clamping type Centralizer is used to grip drill steel or couplings when unscrewing joints in the drill string the driller must be observant to how well the Centralizer Jaws are gripping the Coupling end of the Drill Rod. The driller needs to be sure the centralizer jaws are not worn or damaged and that the jaws are firmly gripping the Coupling when adding or removing drill rods. If used in drilling up-holes the drill string may fall out of the hole and could cause serious injury to the driller or damage to the equipment. On down holes the entire drill string may be lost down the hole and recovery of those valuable rods and bit can be expensive, time consuming and in some cases could be impossible with the consequential loss of both the drill string and the hole. While the drill is running the driller should check over the hose assemblies to ensure no fittings are working loose or for damage to the hose that may allow air or water to leak.

1 Rotation - Lever forward to rotate drill rod clockwise.
Lever back to rotate drill rod counterclockwise.

2 Flushing - Lever forward to active water flushing.
Lever back to active air flushing.

3 Centralizer - Lever forward to open the centralizer.
Lever back to close centralizer.

4 Drill Feed - Lever forward to move the drill forward.
Lever back to move the drill backwards.

5 Percussion - Lever forward to active the percussion.
Lever back to stop the percussion.

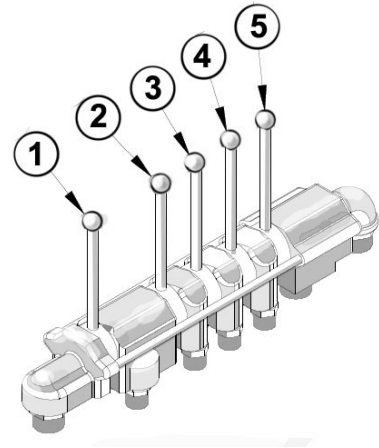

Pulling the Drill String when the Hole is Finished

Once the hole is finished to depth shut down all functions of the drill. Using the Feed Control lever (4) pull the Drill String a few inches from the bottom of the hole. Return the Feed Control lever to the neutral position and with the Rotation lever (1) in neutral push forward on the Percussion lever (5) to hammer the drill string (with no rotation). Allow the Drill to run for a minute or so rattling the Drill Rods. This action will loosen the threads at most joints and make it easier to uncouple the Drill Rods. Move the Percussion lever (5) back until the hammering stops. Using the Feed Control lever (4) retract the drill string until the Coupling end of the second rod enters the Centralizer. Move the Centralizer lever (3) forward to grip the Coupling end of the second rod in the Centralizer Jaws. Move the Rotation lever (1) back to rotate the drill rod spinning the threads of the first rod out of the coupling end of the second rod. Move the Rotation lever (1) to the neutral position and unscrew the first rod from the shank bar by hand and put it to one side. Move the Feed lever (4) forward to advance the Drill up the Feed until the threads of the shank bar enter the Coupling end of the second rod held in the Centralizer. Return the Feed lever (4) back to the neutral position and advance the Rotation lever (1) forward to spin the thread of the shank bar into the coupling end of the second rod. Thread the shank in only a few turns to be sure it is engaged and move the Rotation lever (1) to the neutral position. Move the Centralizer lever (3) back to open the Centralizer Jaws and release the second rod. Push back on the Feed Control lever (4) to retract the Drill back down the Feed carrying the drill string until the Coupling end of the third Rod enters the Centralizer. Move the Centralizer lever (3) forward to grip the Coupling end of the second rod in the Centralizer Jaws. Repeat this process until almost all of the rods have been removed. The last three or four rods can be removed by hand by leaving the Drill in the retracted position on the Feed and using just the Centralizer Control lever to open and close the Jaws on the remaining Coupling ends of the last few rods.

Tips:

Take care when removing drill string from an up-hole as a long string of rods can be very heavy. A sixty (20 meter) drill string of 1.5 inch (38mm) diameter male-female rods weighs 330lbs (150kg). The string will come out of the hole at a dangerous speed if it is dropped through improper procedures. The rods removed from the hole should be placed in a clean storage area, either threaded end down on a clean board next to the wall with the coupling end leaned against the wall or in a drill rod rack. It is important to be sure no debris is present in the coupling end or on the threads when adding drill rods to the drill string while drilling.

1 Rotation - Lever forward to rotate drill rod clockwise.
Lever back to rotate drill rod counterclockwise.

2 Flushing - Lever forward to active water flushing.
Lever back to active air flushing.

3 Centralizer - Lever forward to open the centralizer.
Lever back to close centralizer.

4 Drill Feed - Lever forward to move the drill forward.
Lever back to move the drill backwards.

5 Percussion - Lever forward to active the percussion.
Lever back to stop the percussion.

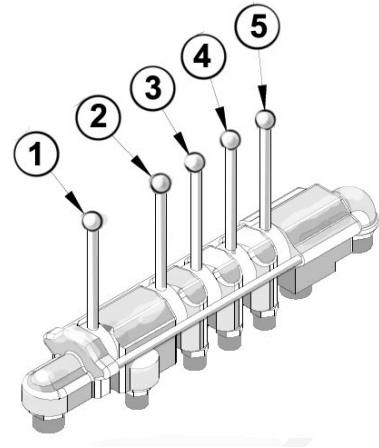



PHQGlobal

PHQ36IR Long-Hole Drill Set-up OPERATING MANUAL



PHQ36IR Long-Hole Drill Set-up on a PHQ3000LHP Pneumatic Carrier

Update June. 2017

Operating procedure

The 36IR Drifter is designed for a long and economical life drilling holes of 38 mm to 75 mm in diameter up to 30 m in depth. Correct application and use of the machine will ensure maximum performance and economy are obtained. A Drill Carrier eliminates the time consuming and demanding work of moving the drill set-up from one site to the next. Skilled drillers have more time and energy to devote to drilling.

Specifications:

| | | |
|---------------------------------|------------------------------|-------------------|
| Bore | 114 mm | 4.49 inches |
| Stroke | 86 mm | 3.39 inches |
| Overall Length | 870 mm | 34 inches |
| Mass (Weight) | 120 kg | 265 lb |
| Blows per Minute | 1630 at 500 kPa | |
| Frequency | 27 Hz @ 500 kPa | |
| Air Requirements (optimum) | 12 L/sec @ 7 bar | 450 cfm @ 100 psi |
| Water Requirements (optimum) | 37 L/min @ 5 bar | 10 gpm @ 70 psi |
| Drill Percussion Air Connection | 40 mm BSP | 1 ¼ inch BSP |
| Rotation Air Connections | 25 mm BSP | 1 inch BSP |
| Centralizer Air Connections | 13 mm BSP | ½ inch BSP |
| Air Water Flushing Connection | 20 mm BSP | ¾ inch BSP |
| Flushing Tube | 11 mm wet 14 mm dry | |
| Rotation Motor Gear Type | 4.0 kW at 120 RPM at 500 kPa | |
| Drill Shank Four Spine | 44 mm | 1 ¾ inch |

Capability:

| | | |
|------------------------------|----------------------|-------------------------|
| Hole Size (Diameter) | 38 mm – 89 mm | 1.5 in – 3.5 in |
| Hole Depth | Up to 46 meters | Up to 150 feet |
| Reaming of pre-drilled holes | From 38 mm to 127 mm | From 1.5 inch to 5 inch |

Mountings

Normally a PHQ36IR Drill is mounted in a MKV Aluminum Screw Feed Aluminum Guide Shell Assembly powered by a STANMO Feed Motor with 1.5-meter (4 foot) change or up to 2-meter (6 foot) change drill rods. The STANMO Feed Motor is available as a single powered motor or as a double (or dual) powered motor with the simple addition of another section to the feed motor. The PHQ36IR Drill may be mounted on a Chain Feed Cradle to suit any existing feed system for an air track or jumbo drill with special mounting details for drilling with up to 3-meter (10 foot) steel changes or longer.

Safety Before Starting the Drill

Drill operators should carefully read all the following safety instructions before beginning. Failure to abide by these instructions could lead to damage to equipment, serious bodily harm or even death.

- Never operate equipment while under the influence of alcohol, medication or drugs.
- Wear appropriate clothing fitted to the body, no loose garments or accessories which could become entangled in machinery. Wear all approved safety equipment, hard hat with ear muffs (and ear plugs), gloves, hard toed boots, safety glasses and any other equipment mandatory to the work place.
- Always have ear protection in place when operating the drills that produce noise above the level of 85dBA. Ear muffs alone are not sufficient to muffle this level of harmful noise from a rockdrill. PHQ recommends wearing ear plugs that shape to properly fit the inner contour of the ear in addition to the mandatory ear muffs.
- Always check the work area when entering at the beginning of a shift to ensure the area is safe to work in. Check the back and walls for loose and scale if necessary. A proper scaling bar should be kept in the workplace at all times.
- Keep the workplace tidy, drill rods stacked neatly, tools elevated out of water puddles on the floor and all unnecessary items removed from the work area to avoid tripping
- Ensure untrained or unauthorized persons are safe in the work area and direct visitors to keep a safe distance from operating equipment, before starting the drill.
- Look over the column bar set-up to be sure it is rigid or the that the Drill Carrier is properly positioned and sitting firmly on all four hydraulic lift cylinders. Tighten all clamp nuts on the double clamp come, swing dump clamp and centralizer clamp to be sure there will be no slippage.
- If the air lines have been disconnected for any reason the air supply hose must be blown to be sure there is no accumulated water or debris in the hose before connecting.
- Flush the water supply hose before connecting it to the Remote Control panel.
- Check the F61 large capacity lubricator to be sure it is filled with sufficient proper rockdrill oil to provide lubrication to the drill for the shift.
- Before opening the air supply ensure all levers on the Remote Control Panel are in neutral or off positions.
- Before operating controls the operator must understand the function of each control.
- Do not exceed the recommended capacity of this equipment by increasing the level of the supply of compressed air pressure beyond 120 cfm (8 Bar).
- Unauthorized modifications to the equipment or use of replacement parts or components not purchased from PHQ or without prior approval from PHQ may render the equipment unsafe to operate or induce premature failure of components, any changes to the equipment or components voids PHQ's warranty.

Operating Controls

There are five controls for the PHQ36 Independent Rotation drilling machine. They are all contained in a single remotely operated control panel:

1 Rotation - Lever forward to rotate drill rod clockwise.
Lever back to rotate drill rod counterclockwise.

2 Flushing - Lever forward to active water flushing.
Lever back to active air flushing.

3 Centralizer - Lever forward to open the centralizer.
Lever back to close centralizer.

4 Drill Feed - Lever forward to move the drill forward.
Lever back to move the drill backwards.

5 Percussion - Lever forward to active the percussion.
Lever back to stop the percussion.

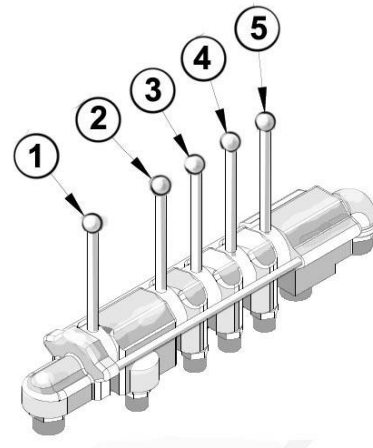

Collaring a Hole

In Brief:

- 1) Position the centralizer and drill bit close to the rock face as possible in the line of drilling
- 2) Move Centralizer lever (3) forward to close the centralizer jaws and stabilize the drill rod.
- 3) Move Flushing lever (2) forward one third (water flowing out of the bit).
- 4) Move Rotation lever (1) forward one third (drill rod and bit rotating clockwise slowly).
- 5) Move Drill Percussion lever (5) forward on third (drill beginning to hammer slowly)
- 6) Move Drill Feed lever (4) forward one third (bit contacts rock face begins chattering)
- 7) Advance and Retard Drill Feed lever (4) to enable the bit to cut a square face on rock.
- 8) After penetration to depth of six inches (150mm) advance all levers to optimize drilling rate.

Detail:

To start or "collar" a hole advance the feed control lever (4) to bring the drill bit within about 10 mm of the rock surface. It is advantageous to square an uneven rock face before collaring holes using a shorter drill rod and a "casing" bit that is larger than the diameter of the bit that will drill the hole. The centralizer is used to hold the drill rod rigidly in place when collaring the hole and should be as close to rock face as the set-up will allow. With the casing bit and rod in place close the centralizer on the drill rod by advancing the Centralizer control lever (3). The rod will still advance through the jaws of the centralizer (as the jaws are designed to grip the coupling end of the rod) and the bit will be held firmly in place to begin collaring the hole. Advance the flushing lever (2) to partially open the flushing control valve and provide a low flow of water to the casing drill bit. Gingerly advance the Drill Percussion control valve (5) to start the drill hammering. Advance the rotation control valve (1) to start rotation of the drill rods at about 50 RPM. The drill string should turn anti-clockwise when viewed from the rear. Continue to advance the feed control lever (4) to feed the drill slowly forwards until the bit starts striking the rock with the hammer running at low frequency and continue to advance the Drill Percussion control valve (5) until about one third open. Advance the feed control lever (4) until the drill string is moving backwards and forwards approximately 10mm. Care must be taken to ensure that forward feed pressure does not cause the collaring bit to slip sideways on the rock face. Running at partial throttle and using the Feed Control lever control pressure against the rock face will establish a clean 'collar' or initial opening to then collar the drill hole on line. Once a good 'collar' has been established gradually advance the feed control lever (4) Drill Percussion control lever to full throttle (5) and Rotation Control lever so rods rotate at about 150RPM. Continue until the bit penetrates about six inches (150mm). Once the hole is well collared and the face of the hole "squared up" shut down the drill and feed, open the centralizer jaws, back the drill on the feed and remove the casing rod and bit.

Drilling in the Floor Installing Casing Pipe:

Drilling in the floor will often require that all the loose rock, dirt and muck be removed from the work place, the exposed surface of rock face blown clean and then inspected for any possibility of “bootleg” holes left from the development work that created the opening. Bootleg holes are usually horizontal holes in the floor area still containing explosives that did not detonate. The explosive can is a serious hazard for a drill operator drilling holes in the floor. It is possible to drill through the “muck” on the floor by first installing a casing to solid rock. This can be accomplished with the driller operating from a remote or shielded location. With the Feed and Drill on-line for the hole loosen the Clamp Cone and drop the Feed so the Centralizer is right down on the floor with the Casing Bit and Short Rod in the drill. Clamp the Feed firmly in the Clamp Cone. The Remote Controls should be pulled as far from the drill as possible and perhaps a robust shield placed between the operator and the hole location. Open the water flushing to full on and drill the casing slowly through the muck until it penetrates solid rock approximately 0.3 meter (1 ft). Stop drilling with the Casing Bit still on bottom with the water flushing still running, loosen the Clamp Cone and use the Feed Control to move the Feed Assembly up until the Centralizer is 0.6 Meter (2 ft) above the floor. Shut down the water flushing and retract the Casing Bit / Rod from the hole. Remove the Casing Bit/Rod and push a suitable length casing pipe into the vacated hole. Replace the Casing Bit/Rod with the first four foot rod placing the bit inside the casing pipe in the hole. Turn on the water flushing to full force and slowly advance the drill bit and rod into the drill hole using rotation only. Press the casing pipe into the hole until it enters the solid rock and bottoms. Resume normal drilling procedure.

1 Rotation - Lever forward to rotate drill rod clockwise.
Lever back to rotate drill rod counterclockwise.

2 Flushing - Lever forward to active water flushing.
Lever back to active air flushing.

3 Centralizer - Lever forward to open the centralizer.
Lever back to close centralizer.

4 Drill Feed - Lever forward to move the drill forward.
Lever back to move the drill backwards.

5 Percussion - Lever forward to active the percussion.
Lever back to stop the percussion.

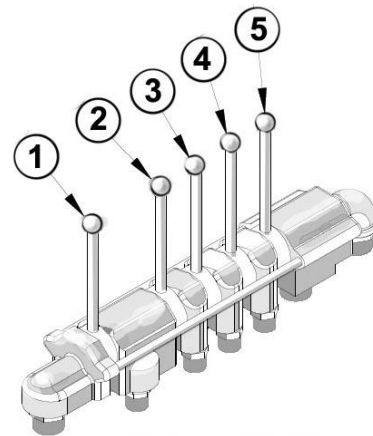

Drilling the first full Drill Rod:

Replace the casing rod-bit assembly with a regular length drill rod and proper sized new bit. Move the drill forward so the bit enters the collared hole. Move the centralizer lever (3) forward to close the centralizer jaws on the drill rod so the bit is held firmly in place and will drill online. Advance the flushing lever (2) to partially open the flushing control valve and provide a low flow of water to the drill bit. Gingerly advance the Drill Percussion control valve (5) to start the drill hammering. Advance the rotation control valve (1) to start rotation of the drill rods at about 50 RPM. The drill string should turn anti-clockwise when viewed from the rear. Continue to advance the feed control lever (4) to feed the drill slowly forwards until the bit starts striking the rock with the hammer running at low frequency and continue to advance the Drill Percussion control valve (5) until about half open. Advance the feed control lever (4) until the drill string is moving backwards and forwards approximately 10 mm. Simultaneously advance the feed control lever (4) the Drill Percussion control lever and Rotation control lever (1). Move the flushing control lever (2) to the full on position and continue to adjust the hammering and feed of the drill until the Drill Percussion valve (5) is fully on. Adjust the feed control valve (4) until drill string oscillation (sideways vibration) is reduced to a minimum. Adjust the rotation control lever (1) to give a rotation speed of about 100-150 RPM. This rotation speed should be adjusted to give the best penetration speed, generally faster for small holes and softer rock, slower for large holes and very hard rock. Continually adjust the control valves until optimum rotation and feed is achieved. Underfeeding produces a lack of a pressure on the bit at the face so it will cut properly and if the drill string oscillation is allowed to increase it causes damage to the rock drill and drill string. Overfeeding at high feed pressure will end all oscillation however the powerful feed motor can exert such a high pressure it may stall the drill rotation or actually push the drill set-up sideways resulting in misalignment of the drill string in the hole. This can have serious consequences. A rigid bar and arm set-up will prevent the movement of the drill set-up.

Alignment

Alignment of the feed so that the drill shank is exactly on line with the hole is the single most important aspect of drilling. The operator must first “collar” the hole properly on line and then monitor the drill rods while drilling to assure the feed and drill remain “on-line” at all times. The drill must maintain sufficient feed pressure so that the drill string is rigid but oscillating (vibrating from side to side) very slightly at all times when drilling. It is most important that the drill set-up include a centralizer or a rigid hole-spotter. The centralizer should be advanced close to the rock face so that it holds the drill rod/bit rigid and does not allow the bit to slip sideways while collaring. There is no need to keep the Centralizer Jaws closed on the Drill Rods once the drill string is well into the hole, however the driller should close the jaws on the drill rod occasionally to check alignment.

Proper Lubrication

Place a wrench in the stream of air exhausting from the drill and check for adequate lubrication of the drill. A fine mist of oil coming from the exhaust should be evident forming on the wrench within a minute. Check the shank bar where it protrudes from the machine there should be a noticeable ring of oil on the shank next to the front cap of the drill when drilling. The driller should stay alert to any lubrication leaking from joints in the Drill Assembly that could signify a problem within. At any sign of excess water exiting the drill from the Front End around the shank shut the Drill down to ensure the Shank Water Seal has not ruptured as this will wash lubricant out of the Drill. Insufficient lubrication can cause catastrophic damage to the Drill in a matter of minutes.

Drilling the hole to depth (adding drill rods)

In Brief:

- 1) Move the Centralizer lever (3) back to lock the drill coupling within the Centralizer Jaws.
- 2) Move the Rotation lever (1) back to unscrew the drill rod from the coupling.
- 3) Move the Drill Feed lever(4) all the way back to rapidly retract the drill
- 4) Insert a new Drill Rod and thread onto the shank one or two turns by hand.
- 5) Move the Rotation lever (1) forward spinning the shank into the rod and rod into coupling
- 6) Move the Centralizer lever (3) forward to open the jaws and resume drilling.

Detail:

When it is necessary to add threaded drill rods from the string, retard the Rotation Control lever (1) to off, move the Drill Percussion lever (5) back to shut the hammer off pull back on the feed control lever (4) to lift the drill string 20 mm off of the bottom of the hole. Move the feed control lever (4) to the neutral position and advance the Drill Percussion control lever (5) to about the half-power position and allow the drill to hammer the drill string that is being held in place. The action of the hammer at half power vibrates the threaded drill rods loose in the string. Turn off the hammer and push the feed control lever (4) forward to position the coupling in the centralizer jaws. Advance the Centralizer Control valve (3) to close the jaws gripping the coupling. Pull back on the rotation control lever (1) to engage reverse rotation to unscrew the rod from the coupling. Only run the machine with reverse rotation the few seconds it takes to separate the drill rod-coupling connection, then move the rotation control lever (1) to neutral, at the same time pull back on the feed control lever (4) to full open position to rapidly pull the drill down the slide opening up space between the coupling held in the centralizer and the end of the drill shank protruding from the drill. Once the drill has reached full retract position on the feed shell return the feed control lever (4) to the neutral position. Place a drill rod coupling end on the shank bar thread and turn on one or two threads by hand. Move the feed control lever to the forward position to move the drill rod towards the coupling held in the Centralizer. The driller should guide the drill rod thread into the coupling. Once the drill rod thread enters the coupling move the rotation control lever (1) forward to spin the threads together and couple the new drill rod into the string. Once the drill string tightens up open the Centralizer Jaws by pulling back on the Centralizer control lever (3). Move the Feed Control lever (4) fully forward, open the Drill Percussion lever (5) Rotation Control lever (1) and Flushing lever (2) fully to resume drilling. The driller needs to monitor the rotation and vibration of the drill string to set the drill at optimum performance by adjusting the controls as the drill continues drilling.

Tips:

When adding drill rods the driller should pick up the rod while the drill is still running and place the threaded end of the rod in the exhaust from the drill. The exiting air will blow off any debris and add a fine coat of lubricant to the threads. The drill should check the striking end of the rod for chips in the face or wear of the threads. When the clamping type Centralizer is used to grip drill steel or couplings when unscrewing joints in the drill string the driller must be observant to how well the Centralizer Jaws are gripping the Coupling end of the Drill Rod. The driller needs to be sure the centralizer jaws are not worn or damaged and that the jaws are firmly gripping the Coupling when adding or removing drill rods. If used in drilling up-holes the drill string may fall out of the hole and could cause serious injury to the driller or damage to the equipment. On down holes the entire drill string may be lost down the hole and recovery of those valuable rods and bit can be expensive, time consuming and in some cases could be impossible with the consequential loss of both the drill string and the hole. While the drill is running the driller should check over the hose assemblies to ensure no fittings are working loose or for damage to the hose that may allow air or water to leak.

- 1 Rotation** - Lever forward to rotate drill rod clockwise.
Lever back to rotate drill rod counterclockwise.
- 2 Flushing** - Lever forward to active water flushing.
Lever back to active air flushing.
- 3 Centralizer** - Lever forward to open the centralizer.
Lever back to close centralizer.
- 4 Drill Feed** - Lever forward to move the drill forward.
Lever back to move the drill backwards.
- 5 Percussion** - Lever forward to active the percussion.
Lever back to stop the percussion.

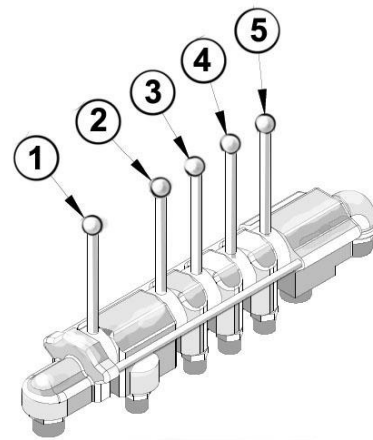

Pulling the Drill String when the Hole is Finished

Once the hole is finished to depth shut down all functions of the drill. Using the Feed Control lever (4) pull the Drill String a few inches from the bottom of the hole. Return the Feed Control lever to the neutral position and with the Rotation lever (1) in neutral push forward on the Percussion lever (5) to hammer the drill string (with no rotation). Allow the Drill to run for a minute or so rattling the Drill Rods. This action will loosen the threads at most joints and make it easier to uncouple the Drill Rods. Move the Percussion lever (5) back until the hammering stops. Using the Feed Control lever (4) retract the drill string until the Coupling end of the second rod enters the Centralizer. Move the Centralizer lever (3) forward to grip the Coupling end of the second rod in the Centralizer Jaws. Move the Rotation lever (1) back to rotate the drill rod spinning the threads of the first rod out of the coupling end of the second rod. Move the Rotation lever (1) to the neutral position and unscrew the first rod from the shank bar by hand and put it to one side. Move the Feed lever (4) forward to advance the Drill up the Feed until the threads of the shank bar enter the Coupling end of the second rod held in the Centralizer. Return the Feed lever (4) back to the neutral position and advance the Rotation lever (1) forward to spin the thread of the shank bar into the coupling end of the second rod. Thread the shank in only a few turns to be sure it is engaged and move the Rotation lever (1) to the neutral position. Move the Centralizer lever (3) back to open the Centralizer Jaws and release the second rod. Push back on the Feed Control lever (4) to retract the Drill back down the Feed carrying the drill string until the Coupling end of the third Rod enters the Centralizer. Move the Centralizer lever (3) forward to grip the Coupling end of the second rod in the Centralizer Jaws. Repeat this process until almost all of the rods have been removed. The last three or four rods can be removed by hand by leaving the Drill in the retracted position on the Feed and using just the Centralizer Control lever to open and close the Jaws on the remaining Coupling ends of the last few rods.

Tips:

Take care when removing drill string from an up-hole as a long string of rods can be very heavy. A sixty (20 meter) drill string of 1.5 inch (38mm) diameter male-female rods weighs 330lbs (150kg). The string will come out of the hole at a dangerous speed if it is dropped through improper procedures. The rods removed from the hole should be placed in a clean storage area, either threaded end down on a clean board next to the wall with the coupling end leaned against the wall or in a drill rod rack. It is important to be sure no debris is present in the coupling end or on the threads when adding drill rods to the drill string while drilling and the operator should check for thread wear of couplings and rods when adding rods.

- 1 Rotation** - Lever forward to rotate drill rod clockwise.
Lever back to rotate drill rod counterclockwise.
- 2 Flushing** - Lever forward to active water flushing.
Lever back to active air flushing.
- 3 Centralizer** - Lever forward to open the centralizer.
Lever back to close centralizer.
- 4 Drill Feed** - Lever forward to move the drill forward.
Lever back to move the drill backwards.
- 5 Percussion** - Lever forward to active the percussion.
Lever back to stop the percussion.

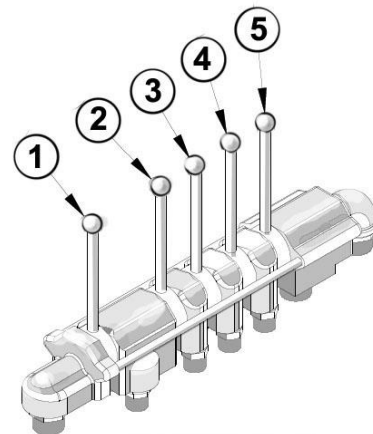

PROPER COLLARING OF HOLES and MINIMIZING HOLE DEVIATION



1) Proper Drill Carrier Setup

- a. It is very important to ensure the drill carrier is levelled on the four lift cylinders so that the wheels are lifted off the floor and all the weight of the drill assembly, traverse and drill carrier provides a firm base for the drilling equipment. It is advisable to place short (24"x 12"x 8") rugged planks under the lift cylinder pads to provide better footing on the rock or dirt floor.
- b. Ensure the drill carrier and drill assembly are "on line" with the drilling direction.
- c. The drill feed is advanced so that the drill centralizer is as close to the rock face where the hole is to be collared. The centralizer plays a critical role in supporting the drill rod/bit when collaring.
- d. Tighten all nuts on the swing dump clamp, double clamp cone, and centralizer eliminate slippage.
- e. Once setup the driller should swing the remote-control arm in to operate from outside the controls.
- f. If the force of the drill feed and hammering of the drill tends to move the drill carrier so that it is "off line" then extra care is required in collaring holes to be sure the hole is "in line" with the drilling direction. Once the hole is collared and the bit has penetrated two or three lengths of drill steel into the rock it is very unlikely that the drill carrier will move.

2) Recommended Drill String

- a. PHQ recommends the use of the largest possible drill string to suit the size of the drill bit.

Bit Size Vs Rod Size

1 $\frac{3}{8}$ " to 1 $\frac{3}{4}$ " 35mm - 44mm

1 $\frac{3}{4}$ " to 2 $\frac{1}{8}$ " 45mm - 54mm

2 $\frac{1}{8}$ " to 2 $\frac{1}{2}$ " 54mm - 64mm

2 $\frac{1}{2}$ " to 6+" 64mm - 152mm

Thread Size

1.0" Thread

1.25" Thread

1.5" Thread

1.75" Thread

Rod Type

R25 - HM25 - T25

R32 - HM32 - T32

R38 - HM38 - T38

R45 - HM45 - T45

Drill Shank Size

1 $\frac{3}{4}$ " x 1 $\frac{3}{4}$ " - 44mm to 44mm

Shank Seal Size

9/16" - 14mm

PHQ provides a proper drill shank in our PHQ36IR Drills at the request of customers

- b. Where a smaller than recommended drill string is used, PHQ recommend the use of a “Casing Starter” to be used only for collaring the hole or drilling to install casing in a down hole. The special rod should be a round rod one size larger than the drill string in use with an adapter coupling (or female end) with the same thread as the drill shank. The bit end should have a larger diameter bit that would match the outside diameter of casing pipe if needed for down holes. Used bits could be used on the Casing Starter as it is only used to establish a “flat face” to collar the regular sized bit of the drill string.
- c. Collaring the hole is the most critical moment at the beginning of a drilling cycle and requires strict adherence to proper drilling techniques

3) Proper Hole Collaring

- a. Collaring the hole in line with the direction of the hole to be drilled is crucial at the beginning of a drilling cycle and requires strict adherence to proper drilling techniques
- b. With the drill rod or Casing Starter supported in the closed jaws of the centralizer the bit should be advanced to just touch the rock face.
- c. With the water supply cracked open so there is a flow of water exiting the bit, the drill throttle should be opened tentatively to provide approximately half power to the drill hammer.
- d. The driller must observe that the bit is cutting squarely into the rock face and with great care advance the feed very gently until the bit is cutting “full face” into the rock.
- e. The bit should be advanced until it is at least two inches into the rock. The driller should check the alignment of the drill rod before gradually opening the throttle and water supply until the drill is penetrating at full power. If the Casing Starter was used to start the hole it should be removed once a “square face” has been achieved and replaced with a regular drill rod and bit. The collaring procedures (b) through (e) should be followed once again.
- f. Once the hole has been advanced one full drill rod the support of the jaws in the centralizer is no longer required to keep the drill steel “in line” and can be opened.

4) Proper Feed Pressures

- a. Once full throttle and maximum feed is in operation the feed pressure must be monitored closely to ensure the drill rods are turning at a proper rotation. One should be able to see the rotation of the drill rod, it should not be spinning at a too high of a rotation speed.
- b. The driller must monitor the penetration of the bit, rotation of the drill rod and the flow of water and cuttings exiting from the drill hole to ensure the drill is performing at maximum capacity.
- c. The driller must check the set-up of the drill carrier to ensure the jumbo has not moved sideways on the lift cylinders putting the drill string out of line. If it has moved drilling should be stopped until the drill can be brought back “in line”.
- d. Misalignment of the drill with the direction of the drill hole is the most common cause of broken drill shanks. This type of breakage is a result of undue side pressure on the drill string and usually will occur in the bottom part of the shank outside the drill at or near the undercut of the thread form on the drill shank.

5) Geological Conditions

- a. Broken, incompetent ground can cause problems with collaring holes. The rock may become loosened by the action of the drill during the collaring process. Pieces of rock break away in the path of the bit causing the bit to *skate* sideways and out of alignment. The drill needs to be retracted and the collaring process begun again.
- b. Banded rock with successive layers of excessively soft and layers of extremely hard formation can lead the drilling bit in the direction of the banding and out of alignment with the drill feed assembly. This problem may require the drill to be backed out of the hole, scaling the rock face and beginning the collaring process again.

6) Summary



- a. Ensure the drill carrier is firmly set-up on line before collaring a hole.
- b. Move the drill feed forward so the centralizer is as close to the rock face as possible.
- c. Use the largest possible drill string or a Casing Starter to start the hole.
- d. Close the centralizer jaws to provide support to the rod with the starting bit.
- e. Feed the bit forward until it is just touching the rock face.
- f. With the feed in neutral open the drill hammer to about one-half throttle.
- g. Tentatively feed the drill forward until the bit has created a “square face” on the rock surface.
- h. Turn on the water to provide sufficient flow to suppress dust from the drill bit.
- i. With drill on reduced hammering gently feed the bit forward until it penetrates about two inches.
- j. Gradually increase feed and throttle until the drill is penetrating efficiently.
- k. Stop to check the drill carrier set-up has not moved during the collaring process.
- l. If the set-up is OK and the drill string in-line continue drilling the hole.

Once the drill is in full throttle the feed pressure must be monitored closely to ensure the set-up is not moving and the drill rod is turning in the hole, in-line with the feed assembly. Hole accuracy is improved if the hole is collared on line. Take the time to set up properly and collar carefully and correctly. The following are a few observations to help minimize the deviation of the hole over the full length of drilling to completion.

7) Minimizing hole deviation

- a. Proper collaring prevents a major cause of hole deviation. A hole collared off one degree will be one foot out of line for every sixty feet drilled.
- b. Proper sized drill rods with couplings (or male female connections) with outside diameter just under the bit diameter are a very large deterrent to hole wander, not to mention providing faster penetration due to the better transmission of blow energy to the bit, and increased water flow to clear cuttings from the hole. Hex drill rods are more rigid and more resistant to bending stresses than round rods of the same diameter. Male-Female drill rods are more rigid than normal threaded drill rods with couplings.
- c. Constant monitoring of the performance of the drill and the drill set-up to ensure drilling is in-line will prevent *side-ways* pressure on the drills string and resulting hole deviation or breaking of drill shanks
- d. Constant monitoring of feed pressure to ensure excessive force is not causing the drill string to yield and bend, tilting the bit “off-center” and deviating in the hole. Especially important when drilling with undersized drill strings. Excessive feed pressure coupled with the weight of the entire drill string in the hole can causes the drill bit to begin to pivot on one of the gauge carbide during rotation and deviate the hole
- e. One should use only sufficient feed pressure to keep the bit firmly seated and in constant contact with the rock face in the bottom of the hole. If one notices the drill carrier set-up lifting or shifting sideways then the feed pressure is excessive.
- f. The driller should observe the flow of water and cuttings coming from the hole and note any sudden change in rate of flow or colour or any sudden change in the rate of penetration that could suggest the bit is entering banded ground or a change in rock formation or possibly fractured or broken ground. Such conditions could cause sudden deviation of the bit in the hole and the driller should back off the feed and lower the hammer to observe the changes. If the drill is continuing to move forward without jerking sticking, or jumping drilling can resume. Ratcheting the drill string back and forth in broken ground with the drill on full throttle can clear the hole however it is doing untold damage to the drill string.

- g. Hole deviation can be lessened with the use of bit guides that keep the bit rigidly in-line in the hole. A guide adapter usually will have ribs to match the diameter of the bit with flutes or channels that allow the flow of water carrying the cuttings to exit the hole. Some proven examples are Retract Bits which have longer bodies and wider skirts that are only slightly smaller than the outside diameter of the bit diameter with flutes to allow cuttings to pass and reversed cutters that so the bit can be “drilled” back out of the hole in bad ground. Retrac bits are more expensive than regular bits, but can prevent hole wander and/or stuck steel – lost holes.
- h. Drop center button bits tend to drill straighter holes than flat or domed faced button bits especially in soft, broken or fractured ground. The drop center creates a slight core of rock in the center of the hole that acts as a centering pilot to keep the bit drilling in a straight direction (the reverse of a pilot hole)
- i. Cross and “X” Type blade bits drill straighter holes than button bits, however are not as readily available, are more expensive and cost more per foot to service than button bits. In many instances blade bits drill slower than button bits, require sharpening and often dull before completing a hole is completed requiring the entire drill string to be pulled to replace the bit and going back down the hole to complete the hole to depth.
- j. Guide couplings a made with a thread sized to the drills string however with an outside diameter to fit just under the hole diameter and flutes to allow passage of drilling water and cuttings. Guide couplings can be spaced throughout the drill string to align the drill string rigidly in-line in the hole.
- k. Wear and tear on rod threads of any drill string used causes excessive thread wear and results in excessive play between mating components to increase the risk of hole deviation. The driller should check thread wear on rods and couplings each time the rods are pulled from the hole and replace worn components in a timely manner to prevent breakage in the hole, stuck steel and possible loss of the hole. If excessively worn couplings are used with new rods thread wear will be accelerated on the new rod, or the worn coupling threads can ride up on the new thread and crack the coupling resulting in stuck steel.

| FAILURE POSITION and TYPE | PROBABLE CAUSE of FAILURE | PHQ GLOBAL RECOMMENDED CORRECTIVE ACTION |
|--|--|--|
| 1. Impact marks, chipped broken corner, or mushroomed end of the striking face  | i) Misalignment in a worn bushing in the chuck driver. ii) Damaged piston | i) Inspect and replace worn bushing B27191 - Do not use damaged shank. Check piston B2739 for similar damage. ii) Inspect and replace worn piston B2739 if necessary. Do not use damaged shank with new piston. |
| 2. Break approximately one inch - twenty millimeters from the striking face  | i) Worn chuck driver or severely worn chuck bushing. ii) Fatigue starting at water seal recess. | i) Inspect and replace worn chuck bushing B2739 and if necessary chuck driver A1845. ii) Examine break for <i>thumbnail feathering</i> ¹ at the break. Forward the broken shank adapter to PHQ Global for quality analysis |

FAILURE POSITION and TYPE

PROBABLE CAUSE of FAILURE

PHQ GLOBAL RECOMMENDED CORRECTIVE ACTION

3. Failure at top of the splines on shank



i) Lack of lubrication

i) Ensure proper flow of rockdrill oil to the frontend of the drill. The shank should be *wetted*² with oil exiting the front end.

ii) Excessive feed force

ii) Monitor feed pressure carefully while drilling to ensure the drill rod is turning properly in the hole.

iii) Worn chuck driver or front bushing

iii) Inspect and replace worn chuck driver A1845 and bushing B2739 if necessary.

4. Failure through the spines of shank.



i) Worn chuck driver

i) Inspect and replace worn chuck driver A1845 and bushing B2739

ii) Heavy rotational torque, and drill rods turning too rapidly (spinning).

ii) Adjust the drilling pressure to ensure the drill rods are not spinning but turning properly.

iii) Lack of lubrication

iii) Ensure proper flow of rockdrill oil to the frontend of the drill. The shank should be *wetted*² with oil exiting the front end.

iv) Over drilling bits

iv) Change bit. Resharpener drill bit if wear flats exceed a third of the insert surface. Discard if carbide height is worn down to the face of the body of the bit.

5. Polishing or wear on the bottom of the shoulders of the splines on the shank



i) Excessive rotation while retracting drill string.

i) Do not rotate drill string when retracting from the hole. If rods stick open the hammer (throttle) partially to rattle the bit past the obstruction without rotation.

6. Failure and collapse at the bottom of the splines on the shank



i) Excessive rotation while retracting drill string

i) Rotate drill string as little as possible when retracting from the hole. Continuing to rotate the drill string while exiting the hole in such a manner will eventually result in breaking the drill shank.

FAILURE POSITION and TYPE

PROBABLE CAUSE of FAILURE

PHQ GLOBAL RECOMMENDED CORRECTIVE ACTION

7. Failure in lower body of shank above the undercut for the thread form.



i) Misalignment of drill feed with the drill rods in the hole while drilling

i) Check the line of the drill feed with the drill rod while drilling to maintain good alignment. Check the amount of wear on ways of the drill body and or the guide shell grooves if drill moves sideways on the feed assembly

ii) Hole deviation

ii) If operations are in order and hole deviations persists employ guide bits or guide couplings.

iii) Excessive feed force

iii) Check the temperature of the couplings while drilling and adjust the feed pressure to ensure a tight drill string but to be sure the rods the turning properly, not spinning.

iv) Misalignment from worn front bushing

iv) Inspect and replace the worn bushing B27191 if necessary. Do not use a damaged shank.

v) Lack of lubrication

ii) Ensure proper flow of rockdrill oil to the frontend of the drill. The shank should be *wetted*² with oil exiting the front end.

8. Failure in the body of the shank at the undercut of the thread form.



i) Misalignment of drill feed with the drill rods in the hole while drilling

i) Check the line of the drill feed with the drill rod while drilling to maintain good alignment. Check the amount of wear on ways of the drill body and or the guide shell grooves if drill moves sideways on the feed assembly.

i) Check the line of the drill feed with the drill rod while drilling to maintain good alignment. Check the amount of wear on ways of the drill body and or the guide shell grooves if drill moves sideways on the feed assembly.

ii) If operations are in order and hole deviations persists employ guide bits or guide couplings.

FAILURE POSITION and TYPE

PROBABLE CAUSE of FAILURE

PHQ GLOBAL RECOMMENDED CORRECTIVE ACTION

9. Failure in the thread form on the shank



i) Misalignment of drill feed with the drill rods in the hole while drilling

i) Check the line of the drill feed with the drill rod while drilling to maintain good alignment. Check the amount of wear on ways of the drill body and or the guide shell grooves if drill moves sideways on the feed assembly.

ii) Mismatched threads

ii) If using drill string components from various manufactures close inspection of the threads of each is required to ensure the thread form matches on each string.

iii) Lack of lubrication

iii) Ensure proper flow of rockdrill oil to the frontend of the drill. The shank should be *wetted*² with oil exiting the front end.

iv) Excessive ratcheting, rattling or rotation of the drill string while not under load.

iv) Avoid extensive *ratcheting*³ of the drill string, either at full throttle or at full rotation when the drill string is not under load. If coupling threads do not loosen freely, inspect the threads. Seized coupling result from over run bits or worn drill threads on rods or couplings.

10 Failure close to the bottom of the thread form above the button.



i) *Excessive percussive pressure*⁴

i) Monitor coupling temperature during drilling and adjust the feed pressure to tighten the drill string but to be sure rods are turning.

11. Thread end or button is chipped



ii) Undetected broken drill steel in the drill string

ii) Driller should examine the end of each drill rod when pulling or changing the string. Replace drill rods with damaged thread faces to avoid *contamination damage*⁵.

iii) Worn coupling

iii) Replace worn couplings. Examine and change out all couplings showing wear when installing new rods.

iv) Shank Adapter not properly coupled to drill steel when hammer and rotation started

iv) Replace damaged shank or worn couplings. Examine the ends of rod threads in the string for *contamination damage*⁵. Remove broken rods.

FAILURE POSITION and TYPE

12. Thread form shows polishing, pitting and/or galling of threads.



PROBABLE CAUSE of FAILURE

i) Shank Adapter not properly coupled to drill steel when hammer and rotation started.

ii) Shank Adapter dropped hard into coupling

PHQ GLOBAL RECOMMENDED CORRECTIVE ACTION

i) Drill rotation and percussion should be adjusted so the bit and drill string penetrates steadily while rotation of the drill string is slow enough that one can observe the steel turning (not spinning).

ii) Care needs to be taken when coupling the drill string. Approach the meeting of the drill rod thread to the coupling slowly. Wait until the rod thread has entered the coupling to begin rotation. Do not use hammering when coupling.

13. Pitting and galling on the sides of the splines of the shank.



i) Over drilled bit. Excessive wear on face carbides and insufficient protrusion of the remaining carbide inserts.

ii) Lack of lubrication

iii) Inadequate feed force

i) Resharpen bits when the wear flats cover one third of the face of the insert. Discard bits when the carbide insert profile height is compromised. Drill using only bits with the sufficient insert protrusion and proper button profile.

ii) Ensure proper flow of rockdrill oil to the frontend of the drill. The shank should be *wetted*² with oil exiting the front end.

iii) Monitor coupling temperatures and adjust the feed pressure according to ground conditions and penetration rate.

14. Excessive polishing or wear on top of spines of the shank.



i) Lack of lubrication

ii) Excessive rotation in soft or broken ground

ii) Ensure proper flow of rockdrill oil to the frontend of the drill. The shank should be *wetted*² with oil exiting the front end.

ii) Adjust the drill rotation and percussion so the drill string and bit penetrate steadily while the rotation of the drill string is slow enough that one can observe the steel turning (not spinning).



PHQ36-IR Independent Rotation Rock Drill PARTS AND REPAIR MANUAL

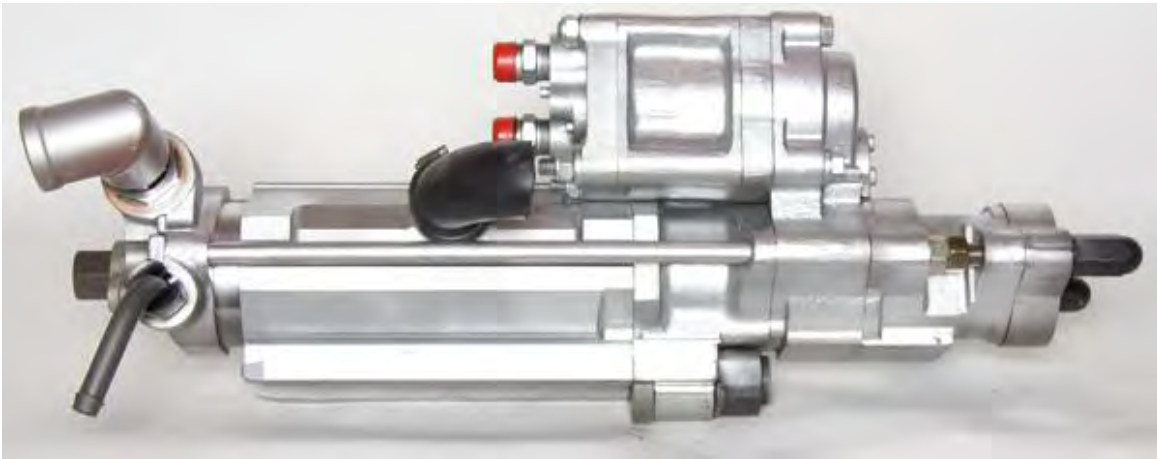

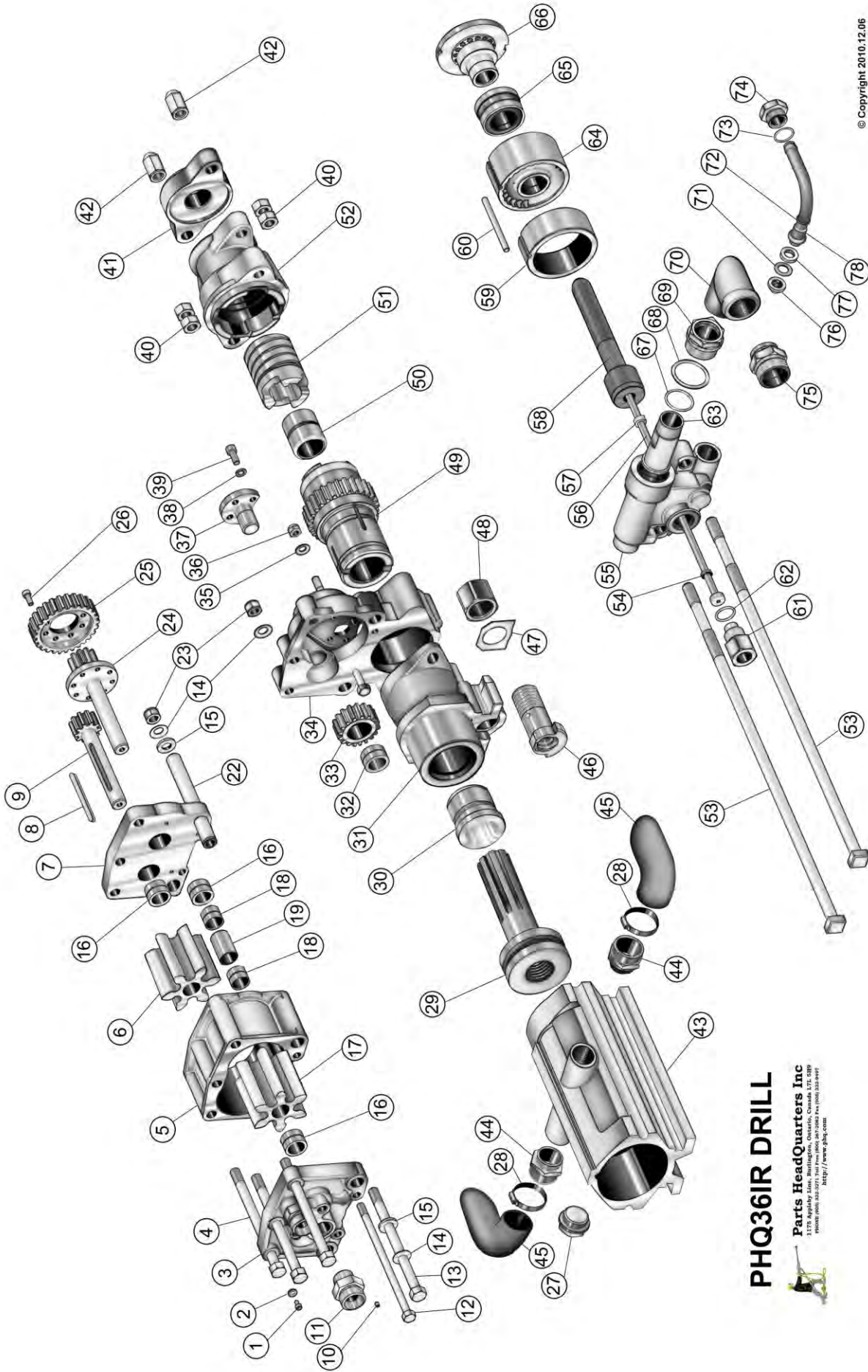

PHQ36IR DRILL

Parts HeadQuarters Inc
 10000 10th St SE, Unit 100
 Everett, WA 98203
 Tel: (425) 336-3333 Fax: (425) 336-3333
<http://www.phq.com>

| <u>DWG #</u> | <u>PART NUMBER</u> | <u>ASSY</u> | <u>DESCRIPTION</u> |
|--------------|--------------------|-------------|---------------------------------------|
| 1 | 109M618 | 4 | CAP SCREW SOCKET HEAD |
| 2 | 14962MT | 4 | SPRING WASHER |
| 3 | A1843 | 1 | COVER, BACK ROTATION MOTOR |
| 4 | C3229 | 3 | CAP SCREW |
| 5 | A1841 | 1 | HOUSING, ROTATION MOTOR |
| 6 | B2645 | 1 | ROTOR, ROTATION MOTOR - KEYED |
| 7 | A1844 | 1 | COVER, FRONT ROTATION MOTOR |
| 8 | 23504316 | 1 | KEY |
| 9 | B2651 | 1 | PINION DRIVE |
| 11 | 1356663 | 2 | SPUD, HOSE |
| 12 | C3227 | 2 | CAP SCREW |
| 13 | C3228 | 2 | CAP SCREW |
| 14 | 149163MT | 10 | WASHER, LOCK |
| 15 | D2028 | 4 | WASHER FLAT |
| 16 | 2766161SCN | 4 | BEARING |
| 17 | B2646 | 1 | ROTOR, ROTATION MOTOR |
| 18 | 2766161S | 2 | BEARING |
| 19 | C3221 | 1 | SPACER, BEARING |
| 22 | C3218 | 2 | SLEEVE, LOCATING |
| 23 | 128M16 | 5 | LOCKNUT (66743) |
| 24 | B2649 | 1 | GEAR, PINION |
| 25 | B2650 | 1 | GEAR, COMPOUND |
| 26 | 109M820 | 8 | CAP SCREW, SOCKET HEAD |
| 27 | C17211 | 1 | PLUG, EXHAUST PHQ36IR (OPTIONAL) |
| 28 | 32064 | 1 | CLAMP, EXHAUST (Include with Item 45) |
| 29 | B2739 | 1 | S36 PISTON |
| 30 | B1250 | 1 | LINER, FRONT CYLINDER |
| 31 | A17301 | 1 | FRONT CYLINDER |
| 32 | 2766181SCN | 1 | BEARING |
| 33 | C3219 | 1 | GEAR, IDLER |
| 34 | E558 | 1 | HOUSING REDUCTION |
| 35 | 149122MT | 4 | LOCKWASHER, M12 BELLEVILLE |
| 36 | 128M12 | 2 | LOCKNUT (67605) (1278F) |
| 37 | C3220 | 1 | SHAFT, IDLER GEAR |
| 38 | 143M10 | 4 | WASHER, LOCK HIGH COLLAR M10 |
| 39 | 109M1020 | 4 | CAP SCREW, SOCKET HEAD |
| 40 | D2165 | 4 | LOCKNUT, SIDE ROD |
| 41 | B2720 | 1 | RETAINER, FRONT 44MM |

| <u>DWG #</u> | <u>PART NUMBER</u> | <u>ASSY</u> | <u>DESCRIPTION</u> |
|--------------|--------------------|-------------|--------------------------------------|
| 42 | C1727 | 2 | NUT, SIDE ROD |
| 43 | E89 | 1 | CYLINDER PHQ36 |
| 44 | C17221 | 2 | SLEEVE, CYLINDER EXHAUST |
| 45 | C17791 | 2 | DEFLECTOR, EXHAUST |
| 46 | C3098 | 1 | NUT, FEED SCREW |
| 47 | C3178A | 1 | WASHER, TAB LOCK |
| 48 | C1876SP | 1 | NUT, FOR FEED SCREW NUT (SPECIAL) |
| 49 | A1845 | 1 | CHUCK GEAR |
| 50 | B27191 | 1 | BUSHING, CHUCK 4MM |
| 51 | B2906 | 1 | CHUCK, 44MM 4 DOG |
| 52 | A1847 | 1 | FRONT HEAD |
| 53 | C3290 | 2 | SIDE ROD |
| 54 | D1402 | 1 | SEAL WATER TUBE 14MM |
| 55 | E560 | 1 | BACKHEAD |
| 56 | C3700A | 1 | WATER TUBE 14MM |
| 57 | XLS9 | 1 | SEAL (0947570) |
| 58 | B2827 | 1 | RIFLE BAR, DUMMY 14MM |
| 59 | B2653 | 1 | SPACER, BACKHEAD |
| 60 | C1745 | 1 | PIN, LOCATION |
| 61 | C3038 | 1 | PLUG, WATER TUBE |
| 62 | 1642114 | 1 | O RING |
| 63 | B2455 | 1 | STEM, AIR INLET |
| 64 | A1368 | 1 | VALVE BOX |
| 65 | C2654 | 1 | VALVE |
| 66 | B12701 | 1 | PLUG, VALVE BOX |
| 67 | 164741 | 1 | O RING |
| 68 | D2100 | 1 | WASHER, AIR STEM NUT COPPER |
| 69 | B2454 | 1 | NUT, AIR STEM |
| 70 | C3039 | 1 | FITTING, AIR INLET |
| 71 | D2098 | 1 | SEAL, AIR WATER STEM |
| 72 | 1645703 | 1 | O RING |
| 73 | 1648113 | 1 | O RING |
| 74 | D2017 | 1 | NUT, AIR BEND |
| 75 | 1012425 | 1 | HOSE SPUD (Not Included in Assembly) |
| 76 | D2097 | 1 | PAD, THRUST |
| 77 | D2099 | 1 | WASHER, THRUST |
| 78 | C3036 | 1 | STEM, AIR WATER 19MM |

Maintenance and Repair – Disassembly

Parts HeadQuarters Inc recommends that all major repairs to the interior of the PHQ36IR Rock Drill be carried out in a proper drill shop. The shop should be clean and spacious with a rugged steel work bench and a strongly mounted guide shell to take the weight of the PHQ36 drill. There should be air supply to operate an impact wrench and sufficient volume and flow to test the drill after repairs are completed. Use of an impact gun with proper sockets will greatly speed up the labour time to disassemble and reassemble drills and will also insure that proper torque is applied to the bolts and nuts holding the assembly together. The following equipment and tools will simplify the work

Shop Facility

Heated space (minimum 20' x 30'). If underground the space should be a well lit enclosed (but ventilated) area with concrete floor & white walls. Adequate shelving and/or cupboards to store rock drill parts. Desk and chair for paperwork. 100 psi Compressed air supply. Pressurized clean water supply. 110V Electricity supply.

Shop Equipment

Fifty ton hydraulic press c/w foot pedal operation anchored to floor, rigid steel column bar (cemented into floor) with universal clamps and horizontal bar mounting a swing dump clamp, three foot length of guide shell anchored into the swing dump clamp in a horizontal position. A four foot by eight foot surface of $\frac{3}{4}$ " inch steel plate work bench anchored to floor, 6" Chain type vice bolted to work bench, 20 Lb Vice bolted to work bench. Varsol wash tank c/w pump, washing hoses and supply of solvent, $\frac{1}{2}$ " Pneumatic impact wrench – $\frac{1}{2}$ ' drive and set of impact type sockets, $\frac{5}{8}$ " Electric hand drill c/w full set of drill bits for steel, $\frac{1}{8}$ " Pneumatic hand held die grinder c/w multiple stones, 4 $\frac{1}{2}$ " Pneumatic belt sander c/w 80 grit sanding discs and cut off blade, 6" Pedestal grinder c/w stone and wire brush wheels, small electric cable or chain hoist rated to 500 lbs positioned to swing over work bench.

Tools

$\frac{1}{2}$ " Drive manual torque wrench (0 to 200 ft/lbs), Complete set of open end wrenches, 18" Crescent wrench, 24" Crescent wrench, 18" Pipe wrench, 24" Pipe wrench, Complete set of screw drivers, Ball peen hammers 1lb 3lb 5lb, Rubber (or Plastic) mallets 1lb 3lb 5lb, Complete set of metal punches, Supply of clean rags or paper towels, Supply of triple zero (000) rock drill grease, Six inch long bronze drivers, 2", 1 $\frac{3}{4}$ ", 1 $\frac{1}{2}$ " , 1" diameters, Six inch long steel drivers, 2", 1 $\frac{3}{4}$ ", 1 $\frac{1}{2}$ " , 1" diameters, Hacksaw with supply of blades, Hose Clamp Tool and supply of Hose Clamps, 2", 1 $\frac{1}{2}$ " , 1 $\frac{1}{4}$ " 1" $\frac{3}{4}$ " $\frac{1}{2}$ " ,

Literature – available from PHQ









Large Wall Posters showing exploded view schematic parts drawings and parts list.
PHQ36IR Longhole Drill Set-up Operating Manuals
Drill, Feed, Centralizer, Remote Control and Lubricator Parts and Repair Manuals







Maintenance Underground





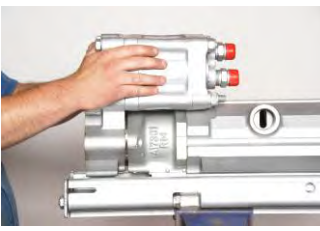



Parts HeadQuarters Inc recomends major interior repairs to the PHQ36IR drill be carried out in a proper drill shop, however many items can be replaced at the drill site underground. Swing the guide shell up to a horizontal position with the drill on top of the guide shell to enable work on the drill. The repairs that should be carried out only in proper shop are shaded in a light blue colour.









1. Invert the drill assembly and using a driver and a rubber hammer straighten the tabs on the Tab Lock Washer (47) on the Feed Nut.

















| | |
|--|---|
| <p>2. Once the tabs are straightened use an adjustable wrench to loosen the Nut for the Feed Screw Nut (48) on the Feed Screw Nut (46).</p> |  |
| <p>3. Remove the Feed Screw Nut (46) and check the inner threads for sign of damage or wear. Replace the Nut for the Feed Screw Nut (48).</p> |  |
| <p>4. Remove the Tab Lock Washer (47) from the Feed Screw Nut (46). Discard the washer and replace with a new washer when re-assembling the drill.</p> |  |
| <p>5. Remove the Feed Screw Nut (46) by driving it from the Drill Cylinder (43) using a bronze driver and a hammer. Examine the threads inside the Feed Screw Nut for signs of wear and replace if necessary.</p> |  |
| <p>6. Using a pneumatic impact gun with a 1 1/4" socket remove the two Side Rod Nuts (42). Check both nuts for any sign of wear and replace if necessary. The nuts can be removed with an eighteen inch crescent wrench at the underground drill site. When the drill is assembled the Side Rod Nuts (42) need to be tightened evenly to a torque of 260Nm (190 ft/lb)</p> |  |
| <p>7. Remove Fronthead Retainer Plate (41). If a new Chuck is required check the inside of the Retainer Plate for wear or signs of fretting of the face that may damage a new Chuck.</p> |  |
| <p>8. Remove Chuck (51) from inside the Front Head (52). Check inside the chuck by inserting a new shank bar and rotating to measure wear. Check the faces of the chuck for fretting marks that may have been caused by a lack of lubrication. Examine the ear lugs on the Chuck (51) that mate with the Chuck Gear (49) for any sign of wear or damage to the mating faces.</p> |  |
| <p>9. Unscrew the Lock Nuts (82) on the Side Rod in the space between flanges on the Front Head (52). Check the nuts for wear and replace these inexpensive parts if any wear is noticed.</p> |  |









| | |
|---|---|
| <p>10. Remove the Front Head (52) by sliding off the Side Rods. Check the inside diameter of the Front Head for wear. Pay particular attention to the Front Head face to see if fretting wear is occurring between the Front Head (52) and the Reduction Housing (34).</p> |  |
| <p>11. Remove the Chuck Gear (49) complete with Chuck Bushing (50) from the front of the Rotation Motor portion of the drill Cylinder Assembly. Check the Chuck Bushing for wear and set aside for removal and replacement if wear is apparent. Check the exterior of the Chuck Gear for damaged teeth. Replace if necessary.</p> |  |
| <p>12. Remove both of the Side Rods (53) by sliding back through the Backhead (55). Check the side rods for wear in the areas where the rods align against meeting of component housings. Pay special attention to the areas where the Front Cylinder Washer (31) meets the Drill Cylinder (43) as well as where the Front Head (52) meets the Reduction Housing (34) as rotation of the faces of these major components within the drill may have worn into the side rod weakening the rod to failure point.</p> |  |
| <p>13. Grip the Reduction Housing (34) which is part of the Rotation Motor Assembly (S36IRROTMO) firmly with two hands and pull to separate the entire assembly from the Front Cylinder Washer (31). The housing comes off complete with the Drive Gears, Air Motor and Air Connection Fittings still in place. Set the motor aside to be disassembled later. Check the mating faces between the Motor and Front Cylinder for wear.</p> |  |
| <p>14. PHQ recommends purchase of a spare complete Rotation Motor Assembly Part Number S36IRROTMO as this complete assembly could be carried underground as a working unit to replace a failed rotation motor in a production drill. The faulty S36IRROTMO can be carried to the drill shop for repair and re-assembly with minimum disruption to production drilling.</p> |  |
| <p>15. Unscrew the Air Inlet Fitting (70) from Air Inlet Stem (63). Check the threads on the Air Inlet Fitting and in the Air Inlet Stem for wear and replace if necessary.</p> |  |
| <p>16. Unscrew the Air Stem Nut from the Backhead (55) take care not to lose the Air Stem Nut Copper Washer (68)</p> |  |
| <p>17. Remove the Air Stem Nut Copper Washer (68) from the Air Stem Nut. Check the washer for wear and replace if worn or corroded.</p> |  |







| | |
|--|---|
| <p>18. Remove the Air Stem Nut (69) from the Air Inlet Stem (63) Check the threads on both parts for wear and replace if necessary.</p> |  |
| <p>19. Remove the O Ring (67) from the Air Stem Nut (69) and check for damage or wear to the O Ring. O Rings are inexpensive items and should be replaced if they appear to be even slightly worn or damaged. The O Ring should be rolled between the fingers to be sure it is still soft and pliable and not turning brittle in use.</p> |  |
| <p>20. Unscrew the Air Bend Nut (74) from the Backhead (55) to remove the Air Water Stem Assembly (78). Check the threads on the nut and replace if necessary.</p> |  |
| <p>21. Remove the O Ring (73) from the Air Bend Nut (74). Check for wear or damage to the O Ring and replace if necessary. An O Rings is an inexpensive item and should be replaced if it appears to be even slightly worn or damaged. The O Ring should be rolled between the fingers to be sure it is still soft and pliable and not turning brittle in use. A brittle O Ring is sure to fail once any pressure is exerted on the parts.</p> |  |
| <p>22. Remove the Thrust Pad (76) from the inside the inlet in the Backhead (55) where the Air Bend Nut (74) threads in. Check the thrust pad for wear and replace if necessary.</p> |  |
| <p>23. Disassemble the Air Water Stem Assembly removing the Air Water Stem Seal (71), the O Ring (72) and the Thrust Washer (77). Check all the parts for wear and replace if necessary.</p> |  |
| <p>24. Remove the Water Tube Plug (61) from the Backhead (55). Check the threads on the plug to be sure they are not worn.</p> |  |
| <p>25. Remove the O Ring (62) from the Water Tube Plug (61) Check the O Ring for wear or be sure it is not getting brittle from use. It is good practice to routinely replace inexpensive parts such as O Rings when assembling drills.</p> |  |
| <p>26. Remove the Water Tube (54) from the drill. Check the water tube for wear in the area where the shank bar would rotate on the water tube. Replace if bent, constricted or worn.</p> |  |







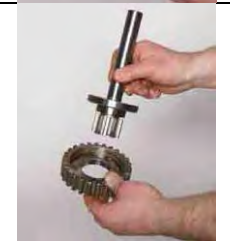

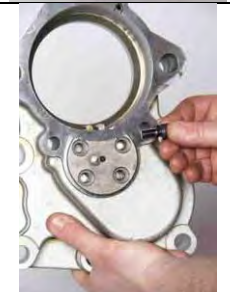

| | |
|--|---|
| <p>27. Remove the Water Tube Seal (54) and replace as a matter of routine maintenance. This is a very inexpensive part however it could shut the drill down if it was to fail while in use.</p> |  |
| <p>28. Remove the two Exhaust Deflectors (45) by loosening the screws in the Exhaust Clamps (28) holding the rubber elbows in place. Examine the Exhaust Deflectors for wear or damage and replace if necessary. The Exhaust Deflector can be replaced with a length of flexible hose to effectively carry the exhausting air and noise from the drill away from the area.</p> |  |
| <p>29. Remove the two Cylinder Exhaust Sleeves (44) and check for wear of the threads. Replace if necessary.</p> |  |
| <p>30. Remove the Backhead (55) from the Drill Cylinder (43). Check the Backhead for any sign of stress wear or cracking. Replace if warranted.</p> |  |
| <p>31. Remove the Dummy Rifle Bar (58) and examine for any sign of wear. This part is used as a "filler" to fill the opening where a rifle bar would operate in a rifle bar rotation drill. The part is not a critical part and should only be replaced if it shows extreme wear or corrosion that may damage parts adjacent to it in the drill.</p> |  |
| <p>32. Remove the Seal (57) from the Dummy Rifle Bar and replace as a matter of routine maintenance. This is a very inexpensive part however it could cause problems with the drill if it was to fail while in use.</p> |  |
| <p>33. Remove the Backhead Spacer (59) from the Drill Cylinder (43) and examine for signs of wear on the faces of the part. This part ensures that the Valve Chest (64) is held securely in place when the side rods are tightened to proper torque.</p> |  |
| <p>34. Remove the Valve Chest Assembly (64) (65) (66). It may be necessary to place a driver into the front of the Drill Cylinder (43) up against the striking face of the Piston (29) and drive the Valve Chest Assembly back out of the Cylinder using a hammer to loosen it from the Cylinder. Care must be taken not to let the Valve Chest Assembly fall to the floor and be damaged. It is a critical part of the drill.</p> |  |
| <p>35. Remove the Location Pin (60) as the Valve Chest Assembly is withdrawn from the Drill Cylinder. Examine the Location Pin for any sign of wear and replace if necessary.</p> |  |

| | |
|--|---|
| <p>36. Hold the Valve Box (64) and remove Valve Box Plug (66) from the Valve Box. It may be necessary to place a bronze driver against the center of the Valve Box Plug and drive it out of the Valve Box with a hammer. Take care not to damage these critical parts as they expensive to replace.</p> |  |
| <p>37. Hold the Valve Box Plug (66) and remove the Valve (65) from the stem of the Valve Box Plug. Examine the parts for wear, damage or corrosion. Clean these parts thoroughly and oil lightly before putting the Valve Assembly back together.</p> |  |
| <p>38. Remove the Piston (29) from the Drill Cylinder (43).</p> |  |
| <p>39. Check the striking face of the Piston for wear caused by the drill shank. Compare worn face (left) to new face (right). The striking end of the Piston can be refaced to a maximum depth of 1/8th of an inch. Check the piston head for scoring or signs of burning or wear from lack of lubrication. Replace if worn or scored.</p> |  |
| <p>40. Set the ROCMO Rotation Motor Assembly on a steady rest with two pins that fit through the holes in the gear housing.</p> |  |
| <p>41. Using the impact gun and a 1" socket loosen the two Locknuts (36) holding the two smaller Cap Screws (12) in place. Examine the locknuts and cap screws for any sign of wear and replace if necessary. When the motor is assembled the two Locknuts (36) need to be tightened to 115 Nm (85 ft/lb).</p> |  |
| <p>42. Replace the Lock Washers (14) and Flat Washers (15) below the Locknuts (23). It is most important that the Cap Screws (12) are firmly held in place and these low cost parts should always be replaced so PHQ recommend that a good supply of these hardware parts be kept in stock in the shop.</p> |  |
| <p>43. Remove the two Cap Screws (12) from the Assembly</p> |  |
| <p>44. Remove the small Cap Screw Socket Head (1) and Spring Washer (2) and check for wear or damage. Replace both parts if required.</p> |  |

| | |
|---|---|
| <p>45. Using the impact gun and a 1 1/8" socket loosen the five Locknuts (23) securing the three Cap Screws (4) and two Cap Screws (13) that hold the Rotation Motor together. When the motor is assembled these five Locknuts need to be tightened evenly to a torque of 280 Nm (200 ft/lb).</p> |  |
| <p>46. Remove the Lock Nuts (23) and Lock Washers (14) from the end of the three Cap Screws (4) and two Cap Screws (13).</p> |  |
| <p>47. Remove the three Cap Screws (4) and two Cap Screws (13) from the Rotation Motor Assembly.</p> |  |
| <p>48. Examine the three Cap Screws (4) and two Cap Screws (13) and the five Locknuts (23) and five Lock Washers (14) for any sign of wear or deterioration. The five Cap Screws are crucial to keeping the Rotation Motor Assembly together and should be replaced at the first sign of deterioration.</p> |  |
| <p>49. Loosen the Rotation Motor Back Cover (3) from the Rotation Motor Housing (5). It may require a light blow from a rubber hammer to loosen the two components.</p> |  |
| <p>50. Remove the Rotation Motor Back Cover (3) and examine the component inside and out for any sign of damage or wear and replace if required.</p> |  |
| <p>51. Using the impact gun and a 1 1/4" socket remove the two Hose Spud (11) air connections from the Back Rotation Motor Cover</p> |  |
| <p>52. When replacing the two Hose Spud (11) air connections be sure to coat the threads with pipe thread compound.</p> |  |

| | |
|--|---|
| <p>53. Remove the two Locating Sleeves (22) from the Rotation Motor Housing (5). It may be necessary to use a bronze driver and a hammer to tap the sleeves free of the housing.</p> |  |
| <p>54. Remove the Rotation Motor Housing (5) from the Front Rotation Motor Cover (7) and examine the faces of the housing for surface pitting or wear. Check inside the gear races to be sure there has been no scoring or wear caused by debris entering the drill.</p> |  |
| <p>55. Remove the Rotation Motor Rotor Keyed (6). It may be necessary to tap the gear off the Pinion Drive (9) shaft with the rubber hammer. Check the gear teeth for any possible damage or scoring.</p> |  |
| <p>56. Remove the Rotation Motor Rotor (17) check the gear teeth for any possible damage or scoring.</p> |  |
| <p>57. Check the face of the Front Rotation Motor Cover (7) for any sign of scoring or wear, and examine the gear shafts. Replace any defective parts.</p> |  |
| <p>58. Remove any remaining Locating Sleeves (22)</p> |  |
| <p>59. Remove the Front Rotation Motor Cover (7) from the Housing Reduction (34) and check the inner side of the cover for any signs of wear or scoring. Replace if necessary.</p> |  |
| <p>60. Examine the face of the Housing Reduction (34) for any signs of wear or scoring.</p> |  |

| | |
|---|---|
| <p>61. Remove the smaller (9) Pinion Drive and check the gear teeth for fretting or damage. Replace if required.</p> |  |
| <p>62. Remove the larger Pinion Gear (24) assembly.</p> |  |
| <p>63. Examine the teeth of the gears on the Pinion Gear (24) and the attached Compound Gear (25) for signs of damaged teeth or corrosion. Replace if necessary</p> |  |
| <p>64. If the Compound Gear (25) is damaged loosen the six Socket Head Cap Screws (6) holding the gear in place on the Pinion Gear (24).</p> |  |
| <p>65. Remove the six Socket Head Cap Screws (6) from the Compound Gear.</p> |  |
| <p>66. Remove the Compound Gear (25) from the Pinion Gear (24).</p> |  |
| <p>67. Using a ratchet wrench and Allen Key loosen the four Socket Head Cap Screws (39) holding the Idler Gear Shaft (37) in place in the Housing Reduction (34).</p> |  |
| <p>68. Remove the four Socket Head Cap Screws (39) the four High Collar Lock Washers (38).</p> |  |

| | | |
|--|--|---|
| <p>69. PHQ recommends replacement of the four Socket Head Cap Screws (39) the four High Collar Lock Washers (38) when the drill is re-assembled.</p> |  | |
| <p>70. Remove the Idler Gear Shaft (37) pulling it from the Reduction Housing (34) and freeing up the Idler Gear (33) complete with the Bearing (32).</p> |  | |
| <p>72. Examine the Idler Gear Shaft (37) and the Idler Gear (33). Check the Bearing (32). PHQ recommend the replacement of the Bearing when reassembling the drill.</p> |  | |
| <p>73. Check the Gear Reduction Housing (34) for signs of corrosion or wear to the faces of the component and inside the Idler Gear race. Check the housing for any cracks or damage that may have occurred.</p> |  | |
| <p>74. Before reassembling the drill replace the two Bearings (16) in the Front Rotation Motor Cover (7) using a hydraulic press in the drill shop.</p> |  |  |
| <p>75. Before reassembling the drill replace the two Bearings (16) in the Back Rotation Motor Cover (3) using a hydraulic press in the drill shop</p> |  |  |
| <p>76. Before reassembling the Rotation Motor replace the two Bearings (18) and the Bearing Spacer (19) in the Rotation Motor Rotor (17) using a hydraulic press in the drill shop.</p> |  |  |

77. Remove the Front Cylinder Washer (31) from the Cylinder (43) This will most likely need to be done using a 20 ton hydraulic press. Examine the faces where the Front Cylinder Washer face and the Cylinder meet for signs of wear.



78. To install the Front Cylinder Washer (31) into the Cylinder (43) the two parts should be slid into a short length of guide shell (from the Feed Assembly) and tapped with the rubber hammer to set the two parts together with correct alignment of the ways of the two parts before the Front Cylinder Washer is press fitted into the Cylinder (43) using the fifty ton hydraulic press in the shop



79. Examine the bronze Front Cylinder Liner (30) in the Front Cylinder (31) for signs of scoring or wear. The liner ensures good compression in the rock drill and should be replaced at the first sign of scoring or wear.



80. Remove the bronze Front Cylinder Liner (30) from the Front Cylinder (31). This is usually done in the drill shop using the fifty ton press. Replace with a new bronze liner using the same shop press to drive it securely into place in the Front Cylinder. This assembly is done in the shop however the assembly could be carried underground to replace at the drill site.



81. When a Chuck Gear (49) is returned to the drill shop with a worn Chuck Bushing (50) the chuck bushing should be removed using the fifty ton hydraulic press in the shop. Examine the Chuck Gear for wear and if it is still in satisfactory condition press in a new Chuck Bushing (50) using the fifty ton shop press. The repaired assembly can be used to replace a worn or damage assembly at the underground drill site.



The completed drill

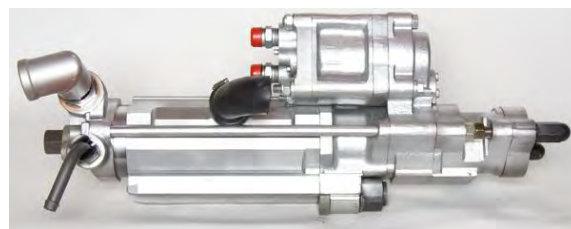



PHQGlobal

PHQ36 MKV Feed Assembly

PARTS AND REPAIR MANUAL



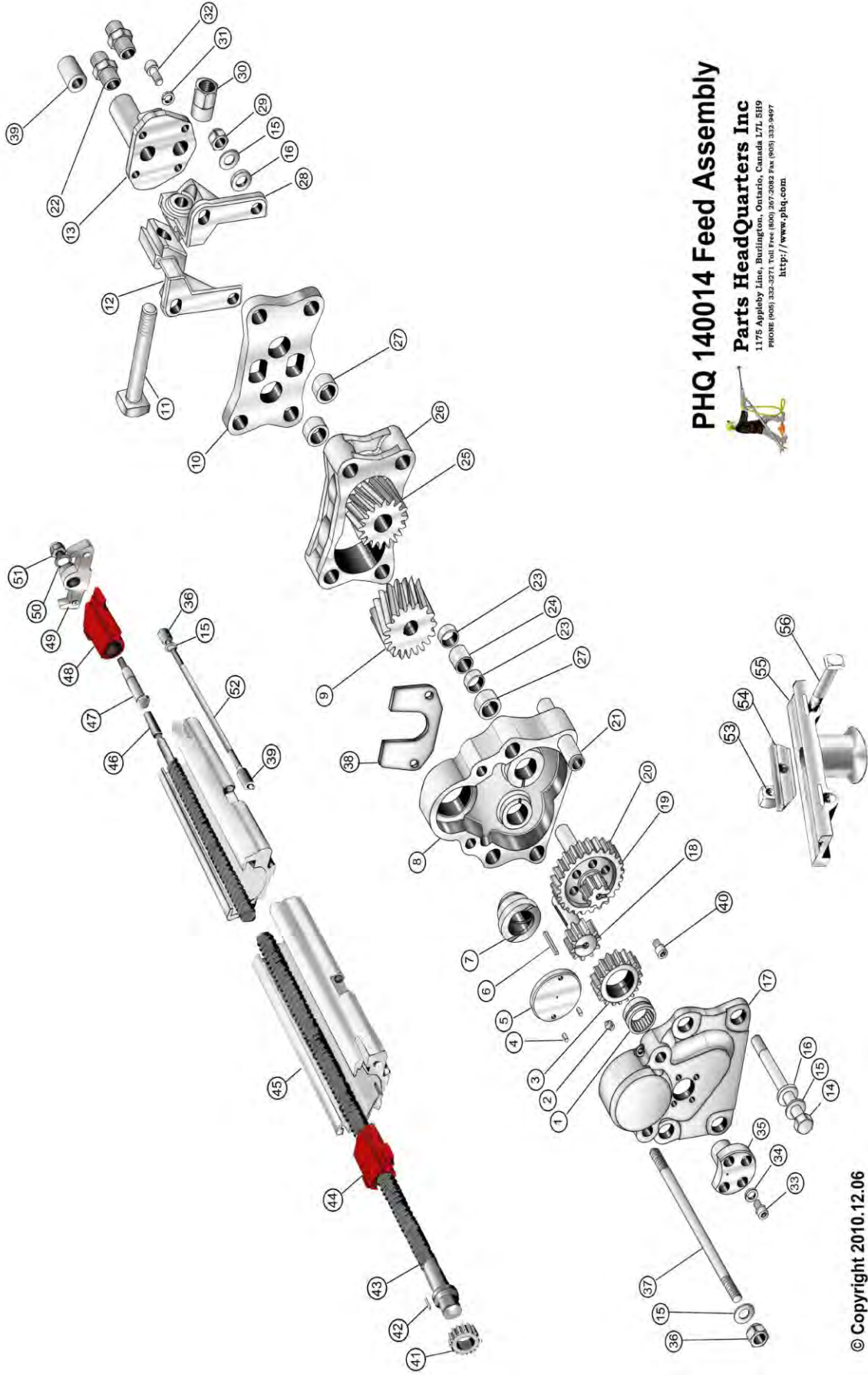

PHQ 140014 Feed Assembly



Parts HeadQuarters Inc
 1175 Appleby Line, Burlington, Ontario, Canada L7L 5H9
 PHONE (905) 332-2271, Toll Free (800) 267-2082 Fax (905) 332-2497
<http://www.phq.com>

Feed Assembly 4' Change

| Key # | Part No. | Qty | Description |
|-------|------------|-----|---------------------------------------|
| 1A | SASTANMO | 1 | FEED ASSY 4' CHANGE NEXT 52 PARTS |
| 1 | 1506102SCN | 1 | BEARING, ROLLER |
| 2 | 16634 | 1 | LUBE FITTING (Z3) |
| 3 | C9582 | 1 | GEAR |
| 4 | 30088 | 2 | PINION |
| 5 | C9581 | 1 | PAD, THRUST |
| 6 | 23502127 | 1 | KEY |
| 7 | C2840 | 1 | BUSHING, FEED SCREW |
| 8 | A1556 | 1 | COVER, FRONT |
| 9 | C2819 | 1 | ROTOR, LARGE |
| 10 | B2244 | 1 | COVER AIR MOTOR |
| 11 | D1508 | 1 | BOLT, SQUARE HEAD 7/8" - 9 X 6" |
| 12 | B2243 | 1 | CLAMP, MOTOR SUPPORT LEFT |
| 13 | B2356 | 1 | PLATE, ADAPTER 19MM HOSE |
| 14 | 10210F70 | 4 | BOLT (SM) |
| 15 | 149163MT | 10 | WASHER, LOCK M16 BELLEVILLE |
| 16 | D2028 | 8 | WASHER FLAT, 16MM EXTRA |
| 17 | A1557 | 1 | COVER, REAR |
| 18 | C2826 | 1 | GEAR, DRIVE |
| 19 | B2242 | 1 | PINION |
| 20 | C2827 | 1 | GEAR, REDUCTION |
| 21 | D2029 | 4 | SLEEVE, LACATING |
| 22 | 1356663 | 2 | SPUD, HOSE |
| 23 | 150841B | 2 | BEARING |
| 24 | D2025 | 1 | SPACER |
| 25 | C2818 | 1 | ROTOR, SMALL |
| 26 | A1701 | 1 | HOUSING |
| 27 | 1502141SCN | 4 | BEARING |
| 28 | B2245 | 1 | CLAMP, MOTOR SUPOPRT RIGHT |
| 29 | 12810F | 4 | NUT, NYLOC M16 |
| 30 | D2026 | 1 | NUT |
| 31 | 143M12 | 8 | WASHER, LOCK HUGH COLLAR M12 |
| 32 | 109M1225 | 4 | CAPSCREW, SOCKET HEAD M12 X 4 |
| 33 | 109M1016 | 4 | CAPSCREW, SOCKET HEAD M10 X 4 |
| 34 | 143M10 | 4 | WASHER, LOCK HIGH COLLAR M10 |
| 35 | C2824 | 1 | SHAFT, IDLER GEAR |
| 28 | C3341 | 1 | PLATE, WEARING |
| 36 | S21187M | 2 | NUT |
| 37 | D2678 | 2 | STUD |
| 39 | C1728 | 2 | NUT (C5943) |
| 40 | 109M816 | 6 | CAPSCREW, SOCKET HEAD M8 X |
| 3A | C2825 | 1 | GEAR, IDLER (OPTIONAL REPLACES 1 & 3) |





| Key # | Part No. | Qty | Description |
|-------|-----------|-----|-------------------------------|
| 1A | PHQ140014 | 1 | FEED MOTOR ASSY NEXT 15 PARTS |
| 15 | 149163MT | 2 | WASHER, LOCK M16 BELLEVILLE |
| 41 | C2836 | 1 | GEAR, FEED SCREW |
| 42 | 2350310 | 1 | KEY |
| 43 | B2602 | 1 | FEED SCREW 4 FT. STEEL |
| 44 | B4335 | 1 | BUFFER, REAR |
| 45 | E456 | 1 | FEED SHELL 4 FT. STEEL CHANGE |
| 46 | C3072 | 1 | BUSHING, FRONT SUPPORT PIN |
| 47 | B2504 | 1 | PIN, FRONT SUPPORT |
| 48 | B4677 | 1 | BUFFER, FRONT |
| 49 | B2505 | 1 | PLATE, FRONT SUPPORT |
| 50 | D2038 | 1 | WASHER, BELLEVILLE 50MM |
| 51 | 128M242 | 1 | LOCKNUT |
| 36 | S21187M | 2 | NUT |
| 39 | C1728 | 2 | NUT (C5943) |
| 52 | D2701 | 2 | STUD |



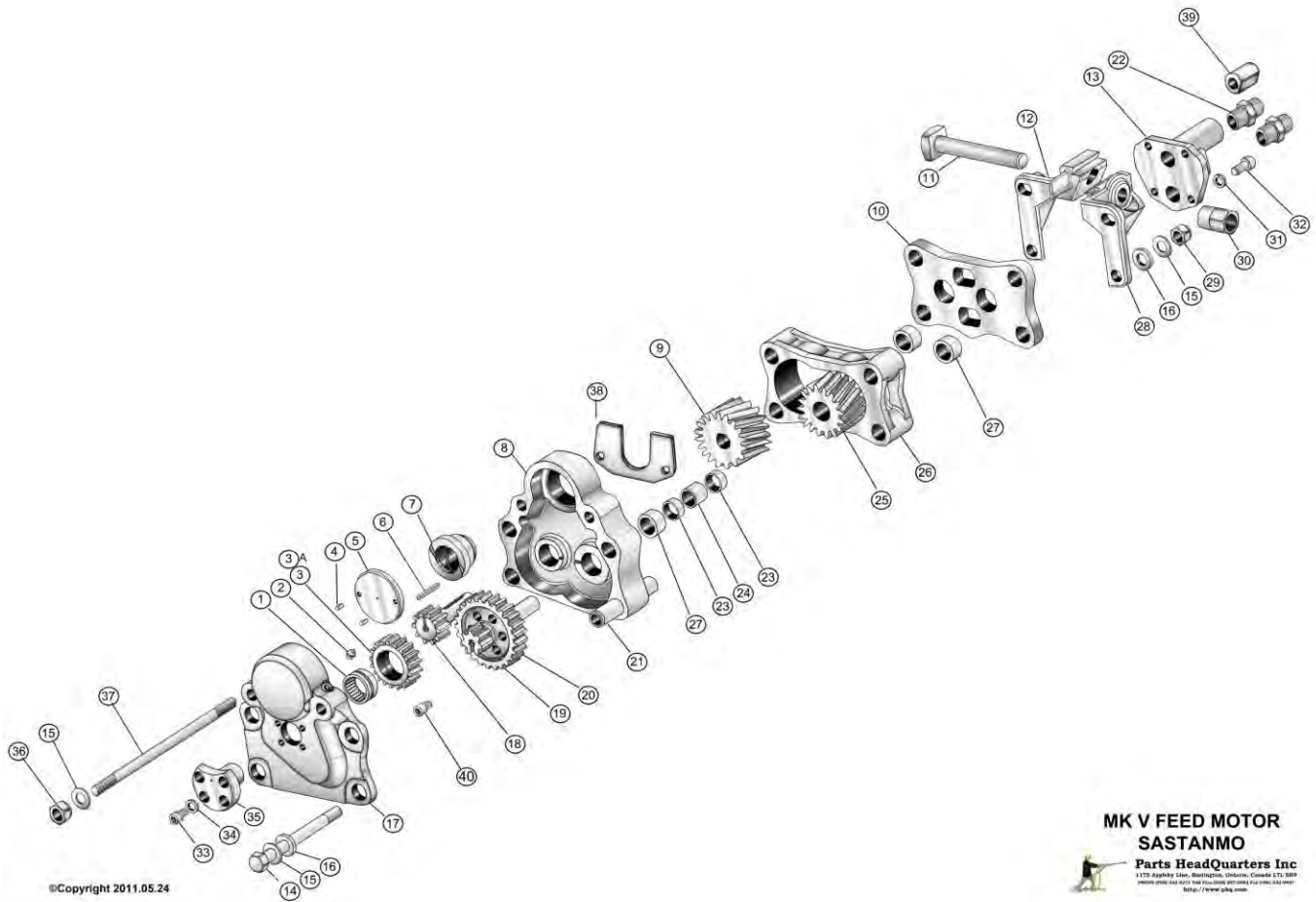





Cone Clamp Assembly







| Key # | Part No. | Qty | Description |
|-------|----------|-----|------------------------------|
| 1A | A7701X | 1 | CONE CLAMP ASSY NEXT 4 PARTS |
| 53 | A770 | 1 | CONE CLAMP |
| 54 | B1276 | 4 | CONE CLAMP PLATE |
| 55 | C1729 | 4 | BOLT |
| 56 | SCJ32 | 5 | NUT |



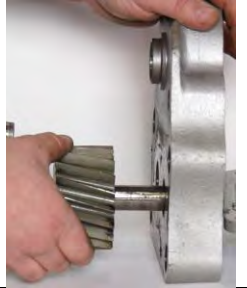



Maintenance and Repair – Disassembly







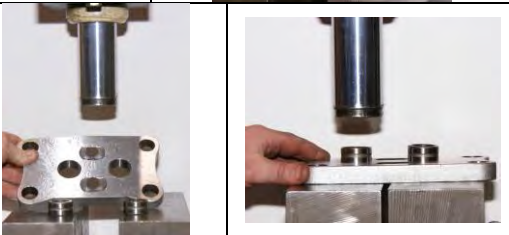











| | |
|--|---|
| <p>101. PHQ recommend one SASTANMO Feed Motor Assembly complete be purchased as a replaceable spare part to be kept at the drill shop for quick turnaround to repair a Drill Feed at the underground drill site. The spare SASTANMO assembly is carried to the drill site and quickly swapped out.</p> |  |
| <p>102. Remove the two loose Studs (37) and two Nuts (36) and two Lock Washers (37) used to hold the SASTANMO to the Feed Shell. Examine the studs and nuts and washers for wear or damage and replace if necessary.</p> |  |
| <p>103. Begin disassembly of the failed SASTANMO using a pneumatic impact gun and socket on the head of the Bolt (16) and holding Lock Nut (29) with an open end wrench.</p> |  |
| <p>104. Remove the four Lock Nuts (29) and the four Bolts (16) along with eight Lock Washers (15) and eight Flat Washers (16) Examine the bolts and nuts and washers for wear or damage and replace if necessary</p> |  |

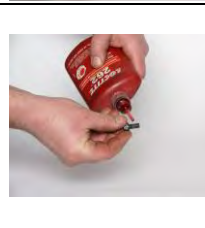



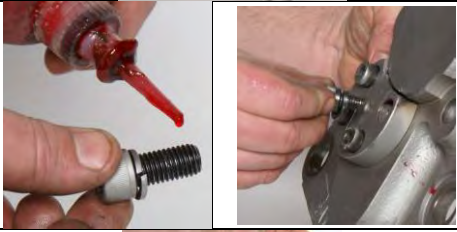

| | |
|--|---|
| <p>105. Grasp the Right Motor Clamp Support (28) and the Left Motor Clamp Support (12) and remove from the assembly. Check the clamps for any sign of damage or cracks. Replace if necessary.</p> |  |
| <p>106. Check over the general appearance of the remaining assembly.</p> |  |
| <p>107. Tap the top of the Rear Cover (17) with the 3 lb plastic mallet to loosen the housings from the Front Cover (8)</p> |  |
| <p>108. Once a slight crack opens up insert a screw driver between the Rear Cover (17) and the Front Cover and carefully pry the two covers apart.</p> |  |
| <p>109. Remove the Rear Cover (17) from the Front Cover (8). Check the faces of the components for wear or corrosion and replace if necessary.</p> |  |
| <p>110. Insert a screw driver between the Front Cover (8) and the Housing (8) of the feed motor and carefully pry the two parts apart.</p> |  |
| <p>109. The Front Cover (8) may prove difficult to remove as there are several shafts running through tight fitting orifices in the component. Use two screwdrivers at either side to gain leverage and move the Front Cover (8) about two inches from the motor Housing (26). This will loosen up the shafts and gears in the Front Cover for easier removal.</p> |  |
| <p>110. Remove the Reduction Gear (20) Pinion (19) Assembly and set aside.</p> |  |

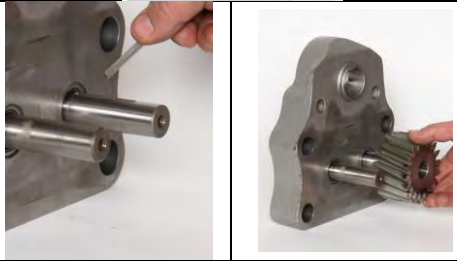
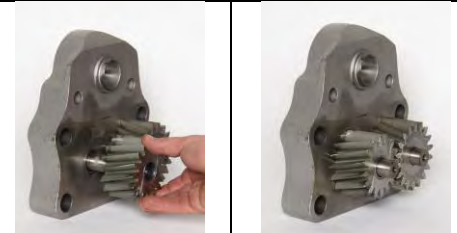
| | |
|--|---|
| <p>111. Remove the Front Cover (8) from the motor Housing (26). Check the faces of the two components for any damage or corrosion.</p> |  |
| <p>112. Remove the Large Rotor (9) and shaft from the shaft of the Gear Drive (18) protruding through the Front Cover (8). Check the Rotor for wear or spalling. Check the Gear Drive shaft and Key (6). Replace any damaged parts.</p> |  |
| <p>113. Insert two screwdrivers in the crack between the motor Housing (26) and the Air Motor Cover (1) and carefully pry the two components apart.</p> |  |
| <p>114. Remove the Air Motor Cover (10) (complete with fittings) from the motor Housing (26) and check the surface of both components for wear or corrosion.</p> |  |
| <p>115. Using the impact wrench and Allen Key loosen the four Socket Head Cap Screws (32) holding the Adapter Plate (13) on the Air Motor Cover (10).</p> |  |
| <p>116. Remove the four Socket Head Cap Screws (32) and four High Collar Lock Washers (31) from the Adapter Plate (13). Replace and Cap Screws and Lock Washers that appear worn or damaged.</p> |  |
| <p>117. Remove the Adapter Plate (13) (complete with the two Hose Spuds (22)) from the Air Motor Cover (10). Examine the mating surfaces of the two components to check for wear or damage. Replace if necessary.</p> |  |
| <p>118. Using the impact wrench with Allen Key tool loosen the four Socket Head Cap Screws (33) in the face of the Idler Gear Shaft (35) attached to the Rear Cover (17). Remove the four Socket Head Cap Screws (33) and four High Collar Lock Washers (34). Screws and Washers and replace any that appear worn or damaged in any way.</p> |  |

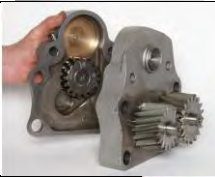
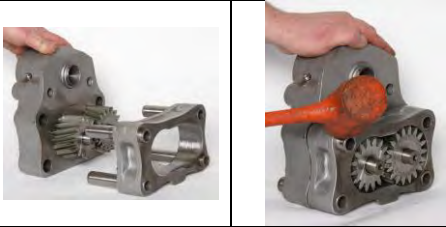
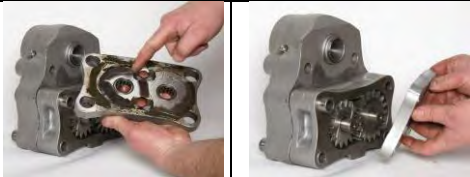
| | |
|--|---|
| <p>120. Drive the Idler Gear Shaft (35) out of the Rear Cover (17) using a three pound plastic mallet. Examine the Gear Shaft for any sign of wear or spalling. Replace if necessary.</p> |  |
| <p>121. Using the electric drill with an Allen Key tool in the chuck unscrew the six Socket Head Cap Screws (4) loosening the Reduction Gear (20) from the Pinion (20).</p> |  |
| <p>122. Remove the Reduction Gear (20) from the Pinion (20). Examine the gear for chipping of the teeth or spalling of the gear surfaces. Check the shaft for wear or corrosion. Replace if necessary.</p> |  |
| <p>123. Use the fifty ton hydraulic press (on low pressure) to push out the two Bearings (27) from the Air Motor Cover (10).</p> |  |
| <p>124. Use the fifty ton hydraulic press (on low pressure) to push two new Bearings (27) into the Air Motor Cover (10).</p> |  |
| <p>125. Use the fifty ton hydraulic press (on low pressure) to push out the one Bearing (27) from the Front Cover (8).</p> |  |
| <p>126. Use the fifty ton hydraulic press (on low pressure) to push a new Bearing (27) into the Front Cover (8).</p> |  |

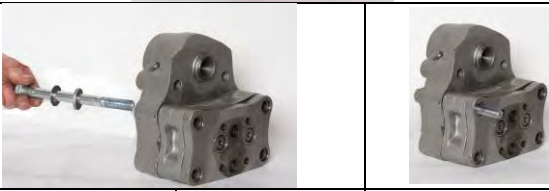
| | | | |
|--|--|---|---|
| <p>127. Use the fifty ton press (on low pressure) to press the two Bearings (23) and Spacer (24) out of the Small Rotor (25).</p> |  |  | |
| <p>128. Use the fifty ton press (on low pressure) to press two new Bearings (23) and Spacer (24) into the Small Rotor.</p> |  |  |  |
| <p>129. Use the fifty ton press to push the Feed Screw Bushing (7) out of the Front Cover (8). Examine the Feed Screw Bushing and replace if scored or worn.</p> |  | | |
| <p>130. Use the fifty ton press to push a new Feed Screw Bushing (7) into the Front Cover (8).</p> |  | | |
| <p>131. Use the fifty ton press (on low pressure) to push two new Bearings (27) into the Front Cover (8).</p> |  |  | |
| <p>131. Place the Reduction Gear (20) on the Pinion (19) and prepare to secure using six Socket Head Cap Screws (40).</p> |  |  | |
| <p>132. Coat the threads of each Socket Head Cap Screw (40) with Loctight (thread locker) and insert through the Reduction Gear (20) to tighten into the Pinion (19). Tighten the Cap Screws securely.</p> |  |  | |

| | |
|---|---|
| <p>132. Insert the Idler Gear Shaft (35) into the Rear Cover (17).</p> |  |
| <p>133. Place the four High Collar Lock Washers (34) on the four Socket Head Cap Screws, coat the threads of each of four Cap Screws (33) with Loctight and thread the Cap Screws through the Idler Gear Shaft (35) into the Rear Cover (17).</p> |  |
| <p>134. Tighten the four Socket Head Cap Screws (33) to hold the Idler Gear Shaft (35) securely in the Rear Cover (17).</p> |  |
| <p>135 Remove the Thrust Pad (50) with the two Pinions (4) from the top of the Rear Cover (17). The Thrust Pad is usually worn and should be replaced each time the Feed Motor is repaired.</p> |  |
| <p>136. Insert the Reduction Gear (20) Pinion (19) Assembly through the Bearing (27) in the Front Cover (8).</p> |  |
| <p>137. Insert the Gear Drive (18) through the Front Cover.</p> |  |
| <p>138. Insert the Key (6) into the slot in the shaft of the Gear Drive (18) protruding through the Front Cover, and slide the Large Rotor (9) onto the shaft of the Gear Drive (18) over the Key (6) locking the rotor into place.</p> |  |
| <p>139. Slide the Small Rotor (25) over the shaft of the Pinion (19) protruding through the Front Cover taking care to mesh the helical gears of the Small Rotor (25) with the helical gears of the Large Rotor (9).</p> |  |

| | |
|--|--|
| <p>140. Slide the Gear (3) with interior Roller Bearing (1) onto the Idler Gear Shaft (35) protruding through the Rear Cover.</p> |  |
| <p>141. Press the Rear Cover (17) to the Front Cover (8) taking care to mesh the gears of the Idler Gear (3) between the teeth of the Gear Drive (18) and the teeth of the Reduction Gear 20). As the assembly comes together turn the Rotors to "feel" the gears working properly between the two components.</p> |  |
| <p>142. Insert the four Locating Sleeves (21) into the appropriate holes through the Housing (26). Match the four Locating Sleeves with the appropriate holes in the Front Cover and push the assembly together. Drive the components together using the three pound plastic Mallet.</p> |  |
| <p>143. Coat the inside of the Air Motor Cover (10) with rock drill grease, match up the two shafts and four Locating Sleeves protruding through the Rotors in the Housing and push the Air Motor Cover on the assembly.</p> |  |
| <p>144. Use the plastic mallet to drive the Air Motor Cover (10) securely into place with the Housing (26) Front Cover (8) and Rear Cover (17).</p> |  |
| <p>145. Insert the four Bolts (14) Lock Washers (15) and Flat Washers (16) through the holes in the Rear Cover (17) the Front Cover (8) the Housing (26) and the Air Motor Cover (10).</p> |  |
| <p>146. Place the Hose Adapter Plate (13) onto the Air Motor Cover (10) and insert the Four Socket Head Cap Screws through the Hose Adapter Plate (13) and threaded into the Air Motor Cover (10). Tighten using the electric drill with an Allen Key in the chuck.</p> |  |
| <p>147. Place the Left Motor Support (12) and the Right Motor Support (28) over the four protruding ends of the Bolts (14).</p> |  |
| <p>148. Slide the four Flat Washers (16) four Lock Washers (15) over the Bolts (14) and thread on the four Nylock Nuts (29). Tighten securely and torque up using the impact gun and appropriate socket.</p> |  |

149. Slide the two Studs (19) (used to attach the SASTANMO Feed Motor to the Aluminum Shell) the two Lock Washers (15) and Nuts (36) through the assembly and place the Feed Plate (3) over the Bolts.



150. Place the two Nuts (3) on the ends of the Bolts (14). Slide the large Square Head Bolt (11) through the holes in the Left Motor Clamp Support (12) and Right Motor Clamp Support (28) and thread on the Nut (30).



The SASTANMO Assembly is ready for transport to the job site when a replacement is needed.



And now for the feed shell to complete the Assembly.....



PHQ 140014 Feed Assembly

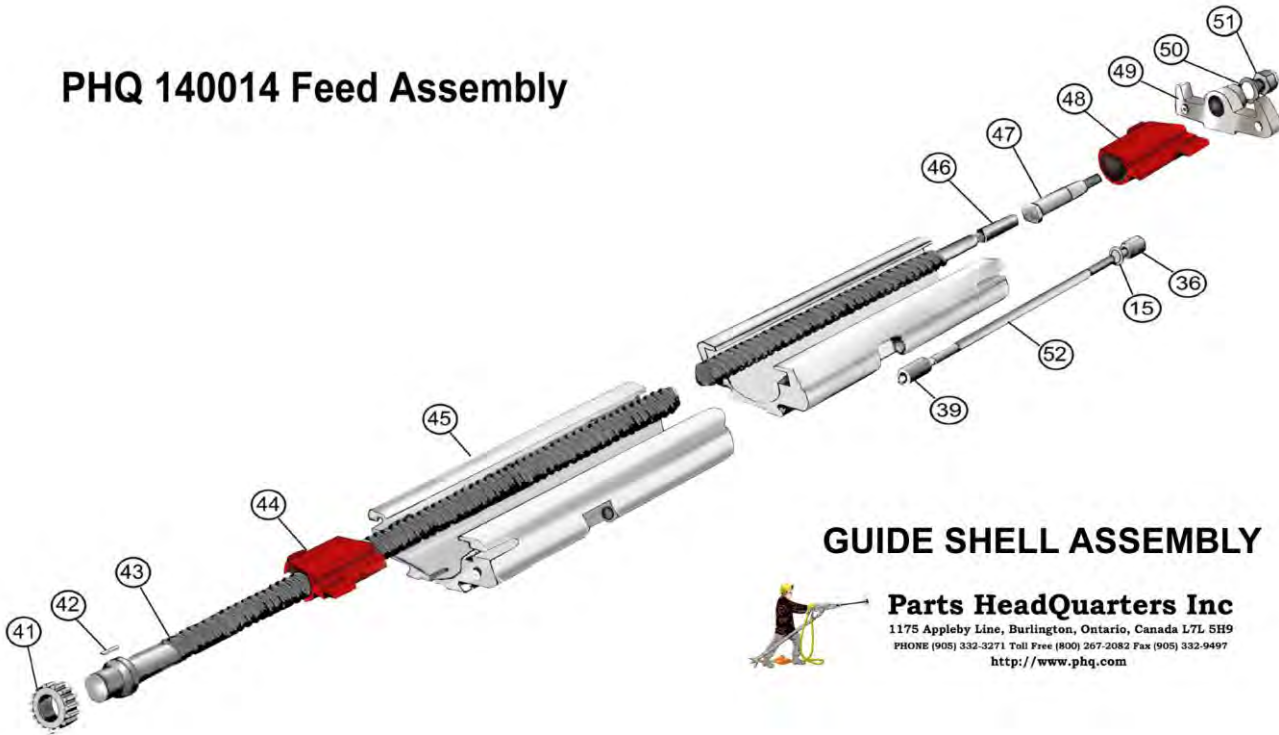

GUIDE SHELL ASSEMBLY



Parts Headquarters Inc

1175 Appleby Line, Burlington, Ontario, Canada L7L 5H9
 PHONE (905) 332-3271 Toll Free (800) 267-2082 Fax (905) 332-9497
<http://www.phq.com>

- | |
|--|
| 151. The remainder of the Feed Assembly is made up of the Feed Screw (43) and the Feed Shell (45) held together by bolts and nuts and the SASTANMO Assembly. |
| 152. The Feed Screw Gear (41) is fixed onto the end of the Feed Screw (43) and over the Key (42). |
| 153. The Rear Buffer is slid over the forward end of the Feed Screw (43) and moved all the way to the back where it fits into two grooves in the end of the Feed Shell (45). |
| 154. The Front Support Pin (47) with the Front Support Pin Bushing (46) installed is slid over the end of the Feed Screw (43). |
| 155. The Front Buffer (48) slides over the Front Support Pin on the Feed Screw (43) and fits into two grooves in the end of the Feed Shell (45) |
| 156. The Lock Nut (51) with Bellville Washer (50) in place is threaded onto the end of the Front Support Pin Plate (49) and tightened. |
| 156. The Front Support Plate (49) is bolted onto the Feed Shell (45) securing the Front Buffer (48) and Feed Screw (43) using two Studs (53) two Lock Washers (15) and two sets of Nuts (36) and (39) |
| 157. The SASTANMO Motor Assembly completes the assembly accepting the Feed Gear (41) through the Front Cover (8) into the Rear Cover (17) butting up against the Thrust Pad (5). Care is to be taken during installation to be sure the teeth of the Feed Gear (41) mesh properly with the teeth of the Gear (3) between the Front and Rear Cover. |
| 158. The SASTANMO Motor Assembly is held onto the Guide Shell Assembly by the two Bolts (37) with two Lock Washers (15) and two Nuts (36) at the back pushed through the Motor Assembly and into the two holes in the end of the Guide Shell where it is held in place by two Nuts (39) in the side slots in the Guide Shell. Once assembled all the nuts must be tightened. |



PHQGlobal

PHQ15001H Heavy Duty Centralizer Assembly PARTS AND REPAIR MANUAL

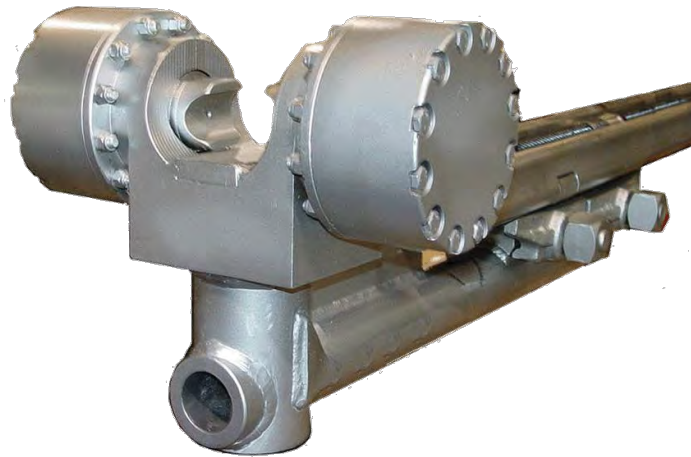

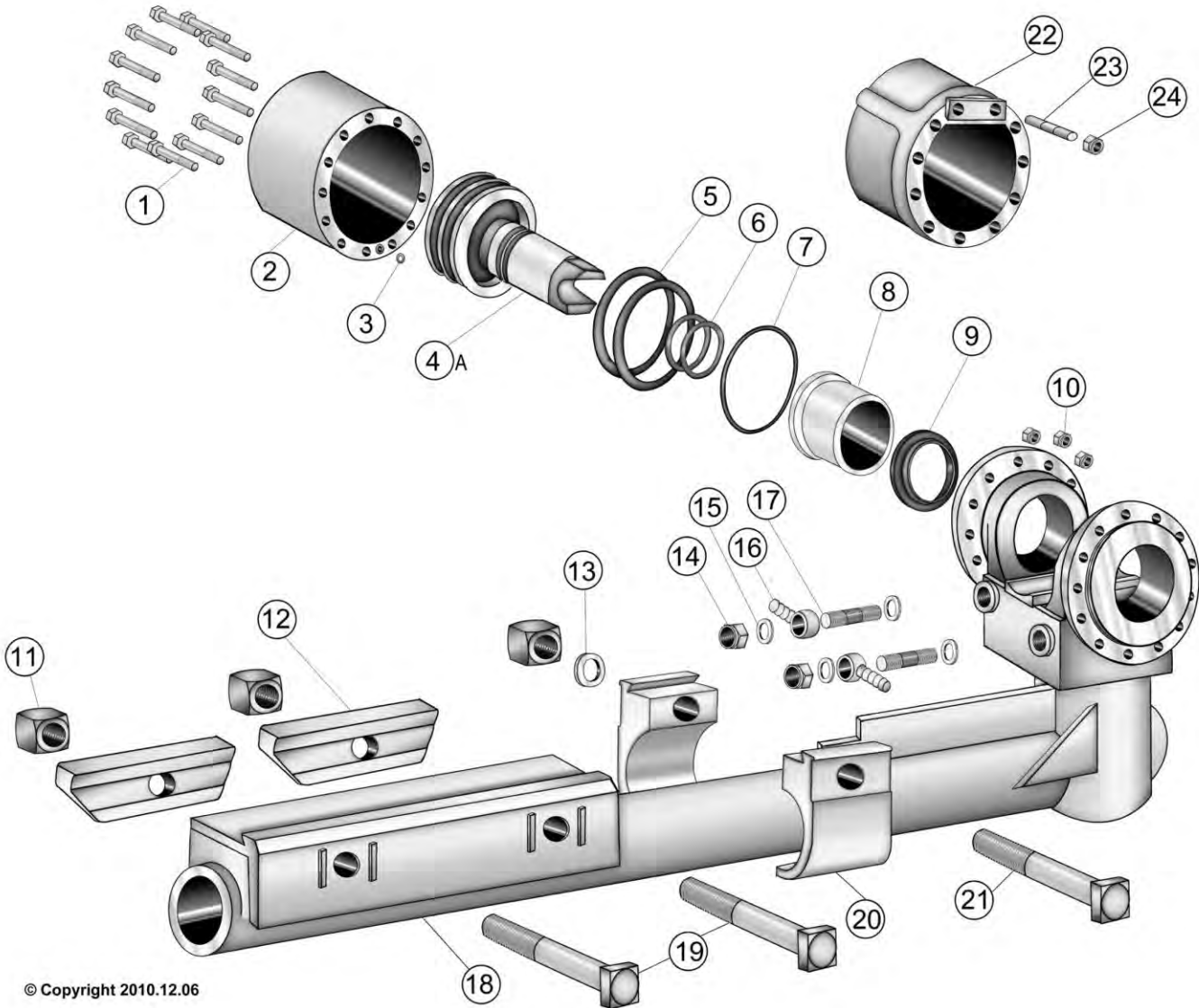

© Copyright 2010.12.06

| Dwg# | Part No. | Qt'ty | Description |
|------|----------|-----------|---------------------------------|
| | 1 | 900056120 | 24 CAPSCREW HEX HEAD |
| | 2 | A1768SP | 2 CYLINDER (SPECIAL) |
| | 3 | 1647302 | 2 O RING |
| | 4A | B2512 | 2 PISTON (ONE PIECE 32MM DRILL) |
| | 5 | 1640548 | 4 O RING |
| | 6 | 1642126 | 4 O RING |
| | 7 | 1645744 | 2 O RING |
| | 8 | C3075 | 2 SLEEVE |
| | 9 | 176621 | 2 HAT PACKING |
| | 10 | 90049081 | 24 LOCKNUT |
| | 11 | COL608/ | 3 NUT |
| | 12 | DM902E | 2 PLATE, CONE CLAMP |
| | 13 | D2118 | 1 WASHER |
| | 14 | 90049056 | 2 NUT, NYLOCK |
| | 15 | D1815 | 4 WASHER, COPPER |
| | 16 | C3191 | 2 FITTING BANJO |

| Dwg# | Part No. | Qt'ty | Description |
|------|----------|---------|---------------------------|
| | 17 | D2018 | 2 STUD |
| | 18 | E534A | 1 SUPPORT |
| | 19 | C1729 | 2 BOLT, CONE CLAMP 7" LG |
| | 20 | A1769 | 1 CLAMP, FRONT |
| | 21 | C3076 | 1 BOLT, FRONT CLAMP |
| | 22 | A1768 | 1 CYLINDER CAP (optional) |
| | 23 | 228M10' | 24 STUD (optional) |
| | 24 | 128M10 | 24 NUT (optional) |

PHQ 15001H PNEUMATIC CENTRALIZER



Parts HeadQuarters Inc
1175 Appleby Line, Burlington, Ontario, Canada L7L 5H9
PHONE (905) 332-3271 Toll Free (800) 267-2082 Fax (905) 332-9497
<http://www.phq.com>

Maintenance and Repair – Disassembly

| | | |
|--|---|---|
| <p>201. Assembly begins with the Support (18)</p> |  | |
| <p>202. First install the two Sleeves (8) into the head of the Centralizer Support (18)</p> |  |  |
| <p>203. The fifty ton press is used to push the two Sleeves (8) into each side of the head on the Support (18)</p> |  | |
| <p>204. Install a large diameter O-Ring (7) on each side around the large diameter of the next to the bolt holes on the head. These O-Rings provide a seal for the two Cylinders when bolted on.</p> |  |  |
| <p>205. Install Hat Packings (9) into the Sleeves (8) already pressed into the head of the Support (18). Smear with grease to lubricate.</p> |  |  |
| <p>206. Install the two smaller O-Rings (6) on the shaft of each Piston (94). Smear the O-Rings with grease to lubricate.</p> |  | |
| <p>207. Install the two larger O-Rings (5) on each of the heads of the two Pistons (4) and smear with grease to lubricate.</p> |  | |
| <p>208. Place the two Pistons (4) through the Hat Packings (9) in the Sleeves (8) installed in the head of the Support.</p> |  |  |

209. Install the two small O-Ring (3) in the groove surrounding the air port in the face of each of the two Cylinders (2)



210. Coat the heads of the pistons with grease for lubrication. Place the open end of the two Cylinders (2) over the heads of the protruding Pistons (4) on each side of the head of the Support (18). Drive the Cylinders on using the five-pound plastic mallet.



211. Install the twenty-four Cap Screws (1) and twenty-four Nuts (10) through the Cylinder (2) and head of the Support (18) (Twelve per side). Tighten with the impact gun and socket.



212. Insert the two Studs (17) four Copper Washers (15) two Banjo Fittings (16) and two Nylock Nuts (14) into the two air inlet holes in the head of the Support (18) to complete the air fittings



213. Install the two Cone Clamp Plates (12) with the two Cone Clamp Bolt (19) and Nuts (11). Repeat the procedure to install the tow Front Clamps (20) using the Front Clamp Bolt (21) Washer (13) and Nut (11).

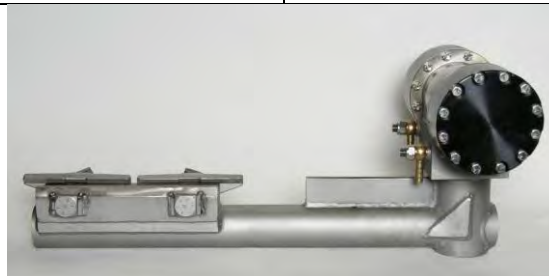

The PHQ15001H Heavy Duty Centralizer Assembly is now complete and ready for transport to an underground drill site to replace a failing Centralizer



PHQGlobal

PHQ21002
Remote Control Assembly
PARTS AND REPAIR MANUAL



| ITEM NO. | PART NUMBER | DESCRIPTION | QTY. |
|----------|-------------|---|------|
| 1 | A12411 | HOUSING, DRILL VALVE | 1 |
| 2 | 164451P60 | O RING | 5 |
| 3 | D1831 | RING VALVE SEAL | 6 |
| 5 | B18911A | VALVE, DRILL | 1 |
| 6 | C25071 | RING, DUST LEVER | 5 |
| 7 | C2506L | LEVER | 5 |
| 8 | B19491 | HOUSING, FEED AND CENTRALIZER | 2 |
| 9 | B18981A | VALVE, FEED MOTOR CONTROL | 1 |
| 10 | 128M12 | LOCKNUT (67605) (1278F) | 2 |
| 11 | 17412022 | WASHER | 2 |
| 12 | B18971 | VALVE, CENTRALIZER CONTROL | 1 |
| 13 | B18931 | HOUSING, AIR WATER | 1 |
| 14 | C3256 | BOLT, THROUGH | 2 |
| 15 | B18951A | VALVE, WATER | 1 |
| 16 | A1840 | HOUSING ROTATION MOTOR | 1 |
| 17 | 164241P60 | O RING | 6 |
| 18 | B2644 | VALVE, ROTATION MOTOR | 1 |
| 19 | A1849 | HOUSING AIR INLET | 1 |
| 20 | 90030264 | WASHER, LOCK 5/8" | 4 |
| 21 | 11010W1 | BOLT, REMOTE MOUNTING 16MMX | 4 |
| 22 | D1830 | PLUNGER, VALVE | 5 |
| 23 | S3030 | SPRING, VALVE PLUNGER | 5 |
| 24 | D1829 | PLUG, VALVE PLUNGER | 5 |
| 25 | 90246650 | NIPPLE, CLOSE 3/4" | 1 |
| 35A | JC45 | AIR SCREEN ASSEMBLY (INCLUDES 35, 36, 37) | 1 |
| 35 | 910660211 | O RING (JC45) | 1 |
| 36 | 355538 | AIR SCREEN | 1 |
| 37 | 1356588 | SPUD, HOSE (REDUCER) | 1 |

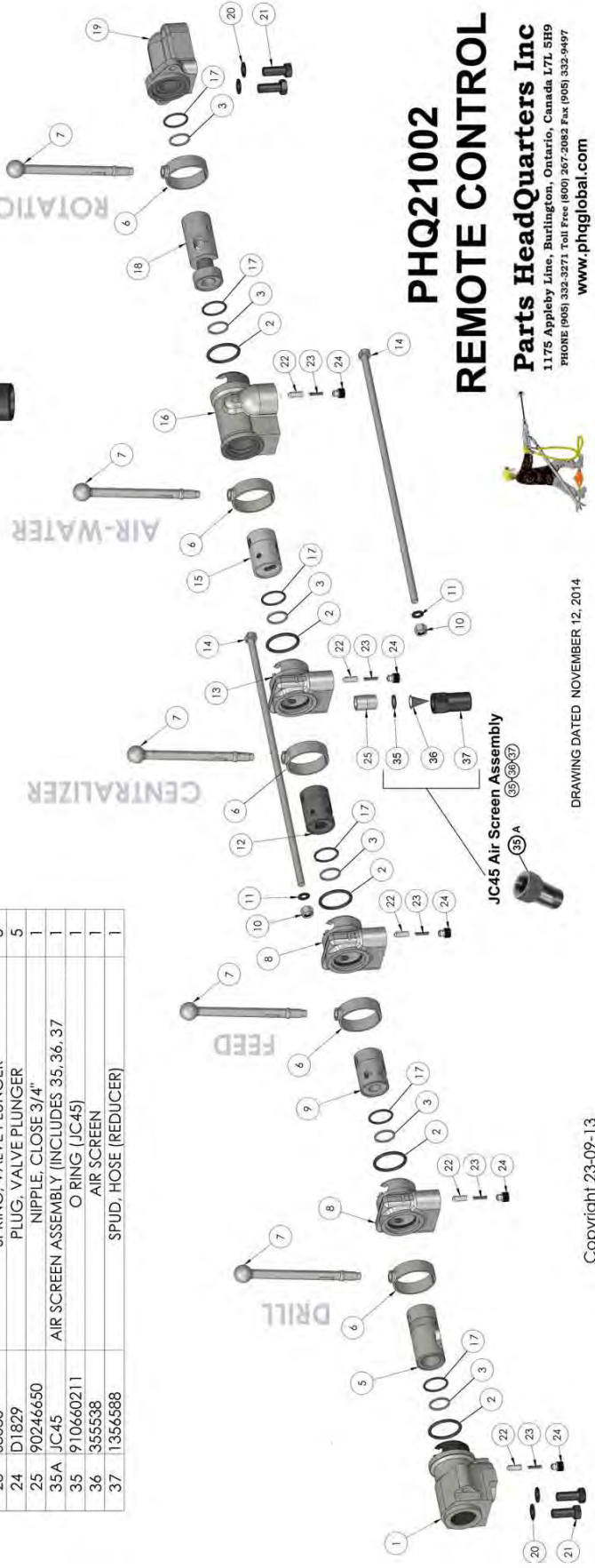
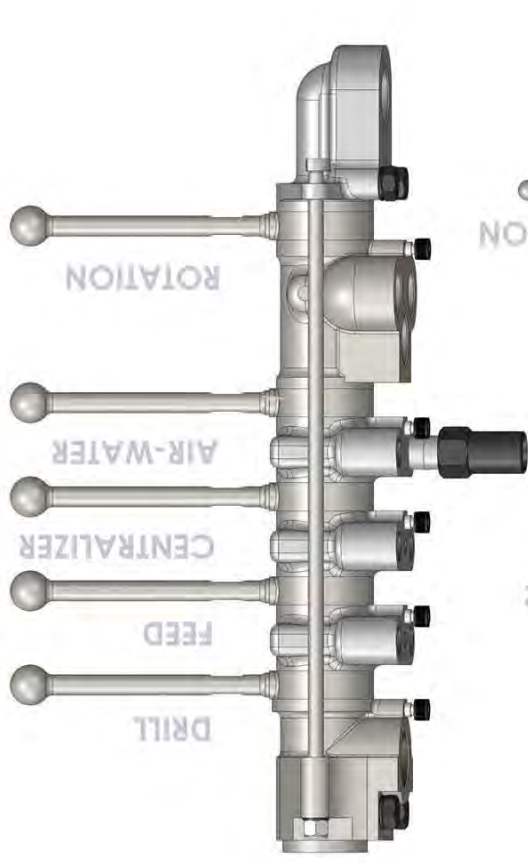

PHQ21002 REMOTE CONTROL

Parts Headquarters Inc
 1175 Appleby Line, Burlington, Ontario, Canada L7L 5H9
 PHONE: (905) 332-3271 Toll Free (800) 267-2082 Fax (905) 332-9497
www.phqglobal.com



DRAWING DATED NOVEMBER 12, 2014

Copyright 23-09-13

The remote-control assembly is relatively straight forward and simple in design and easy to repair following the schematic drawing arrangement provided above. There are five controls for the PHQ36 Independent Rotation drilling machine. They are all contained in a single remotely operated control panel:

1 Rotation - Lever forward to rotate drill rod clockwise.
Lever back to rotate drill rod counterclockwise.

2 Flushing - Lever forward to active water flushing.
Lever back to active air flushing.

3 Centralizer - Lever forward to open the centralizer.
Lever back to close centralizer.

4 Drill Feed - Lever forward to move the drill forward.
Lever back to move the drill backwards.

5 Percussion - Lever forward to active the percussion.
Lever back to stop the percussion.

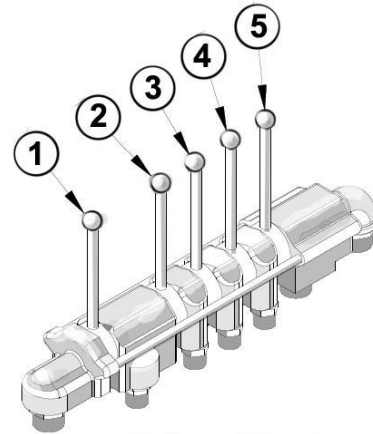

- 1) Inlet air from dual ports exiting the F61 lubricator are connected to both ends of the remote-control panel with 2" (51mm) high pressure hoses.
- 2) The rotation motor on the drill is connected with 1" (25mm) high pressure hoses.
- 3) The air and water flushing is connected with 1" (25mm) high pressure hose.
- 4) The Centralizer is connected with ½" (13mm) high pressure hoses.
- 5) The Feed is connected with ¾" (19mm) hoses
- 6) The Percussion is connected with 1½ "(38mm) hose.

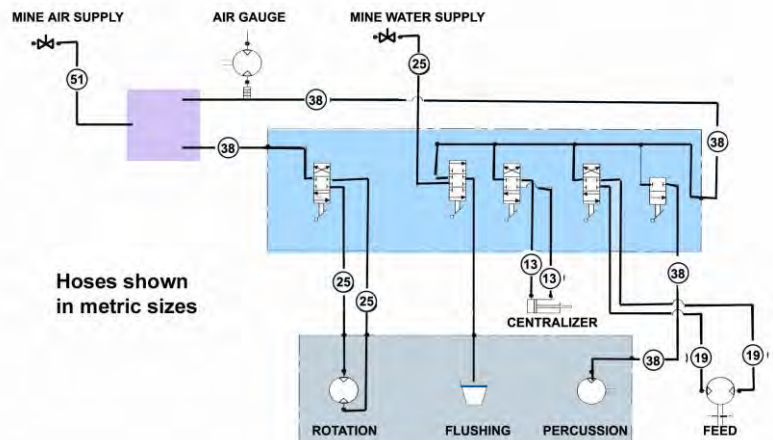
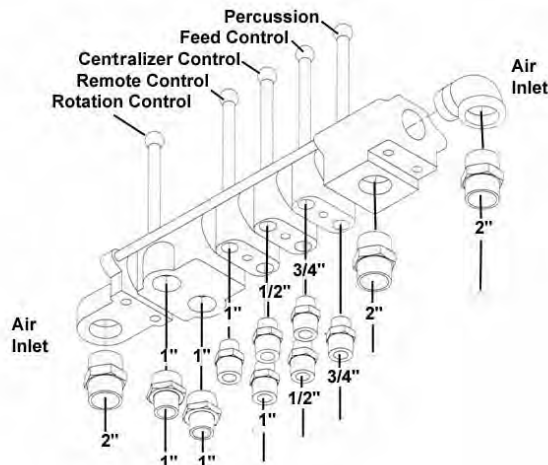



PHQGlobal

PHQ F61
Dual Feed Large Capacity
Lubricator Assembly
PARTS AND REPAIR MANUAL



PHQ F61 Dual Feed High Capacity Lubricator

ONE AND ONE-HALF GALLON LUBRICATOR

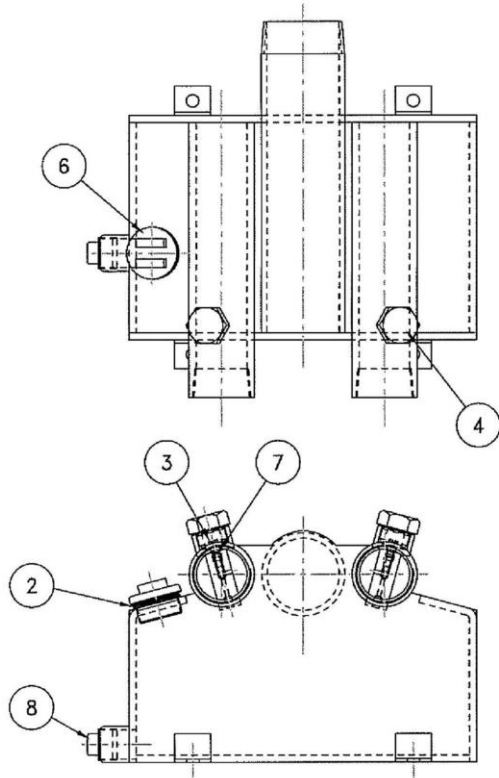

| F61 | | LUBRICATOR ASSEMBLY COMPLETE |
|--------|--------------|-------------------------------|
| PART # | DESCRIPTION | |
| ① | C3273 | FILTER ELEMENT - 1 ONLY |
| ② | 910660224 | FILLER PLUG O RING - 1 ONLY |
| ③ | D1878 | ADJUSTING SCREW - 2 ONLY |
| ④ | D2104 | ADJUSTING SCREW CAP - 2 ONLY |
| ⑤ | F61SF | LUBRICATOR CONTAINER - 1 ONLY |
| ⑥ | 174118211 | FILLER PLUG - 1 ONLY |
| ⑦ | 164-301 | 'O' RING - 2 ONLY |
| ⑧ | 5200078 | TAPER PLUG - 1 ONLY |
| ⑨ | F61 COUPLING | 2 1/2" NPT x 2" NPT REDUCER |

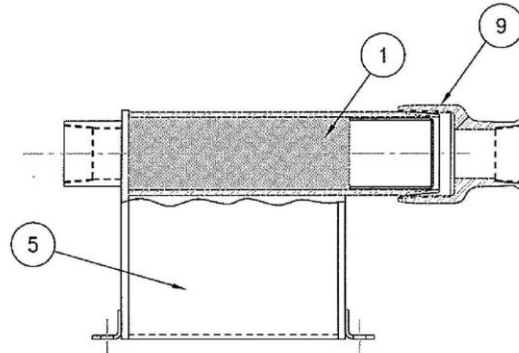

Features

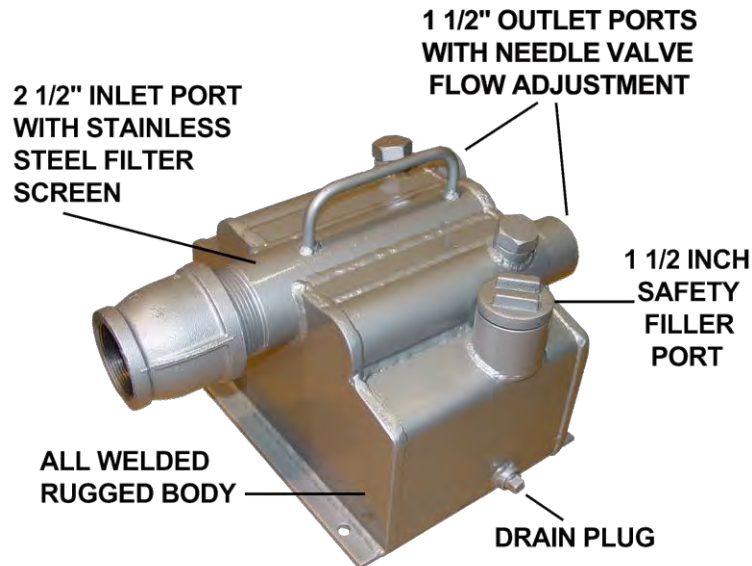

SAFETY TIP: Always shut the air off and bleed the pressure out of the compressed air system containing the F61 Lubricator before attempting to adjust the needle valve flow settings in the F61. The needle valve can unscrew far enough to blow out of the thread holding it in and become a projectile under pressure.



PHQ Global was formed over thirty years ago to supply pneumatic underground mining equipment, parts and mining hardware to the industry.

PHQ Global grew into the manufacturing of complete jacklegs, stopers, drill carriers mounting percussion drills, drill feeds, drill centralizers, remote control panels, mufflers, diamond drills, high pressure pumps, diamond drilling rods, core barrels, adapters and accessories.

PHQ Global cooperated in the research with CANMET and the University of Sherbrooke to develop an anti-vibration handle for rock drills testing our research at CANMET and NORCAT and finally developing a lighter, faster, quieter, Jackleg Drill with a lot less vibration.



PHQ Global continually strives toward excellence

PHQ Global up-graded our in-house quality system in 2009 from ISO9001:2000 to ISO9001:2008 passing the first audit of the up-graded system with absolutely no faults the first time around.

PHQ Global passed our annual re-registration audit of our quality system last year in our Burlington shop with no faults making it the twentieth year in succession of an unbroken sequence of PHQ conforming to quality audits.



QMI-SAI Global

PHQ Global adopted the logo of a miner running a pneumatic hand-held jackleg drill as the symbol of our company and it is an integral part of the Logo that we proudly display. The symbol of a jackleg driller hard at work signifies our company's unwavering commitment to production of dependable pneumatic drilling equipment for the world-wide underground mining industry.

